

INSTRUCTION MANUAL AUTOMATIC JUICER FOR ORANGE



MODEL:OPW150

Electric orange squeezer- manual feed- with drain tap

**Read carefully these instructions before using the
appliance and keep them for future reference**

The juicer is consisted of the stainless steel shell, the trans-parent plastic cover, food-grade plastic parts (Convex ball and Concave ball) and remaining collector. It has anti-corrosion protection and it is easy to wash. It can produce fresh and delicious juice in a few seconds after operation. It is an ideal machine to make juice and is widely used in café, restaurants and hotels. For this appliance are suitable $\Phi 40 \sim \Phi 80$ mm oranges. The operation is simple and convenient. The juicer is small and easy to operate and has instant production of original, tasty and trendy juice.

Technical Parameters:

- Voltage: 220V ~ 50Hz
- Power: 200W
- Size of orange: 40-80mm
- Output: 20 oranges per minute
- Yield: 40-75%



The symbol  on the product means that at the end of its life, the appliance has not to be considered a common waste. It is a special waste and has to be demolished in specific recovery and disposal area, as prescribed by the EC Directive 2002/96/EC (WEEE). By disposing this product correctly, you can avoid negative consequences for the environment and for the human health, due to the presence of potentially dangerous substances in the product.

Before operation

1. The power supply must have the safety grounding system and the machine connection parts shall not be changed by unauthorized person.
2. Check whether all parts are installed well. This product is equipped with safety system and it can work only after the machine mask is correctly installed (and the safety switch button is compressed). Otherwise it is difficult to start the machine.
3. Before using the product for the first time, please thoroughly clean the parts which are in contact with the food.

Operation process

1. Put the juice storage container of your choice on the tray of the base should self provide the juice container).

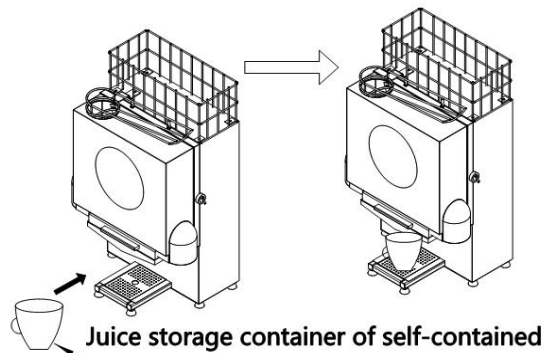

2. Put the fruit peel bucket in the two sides of the bottom of the machine body.

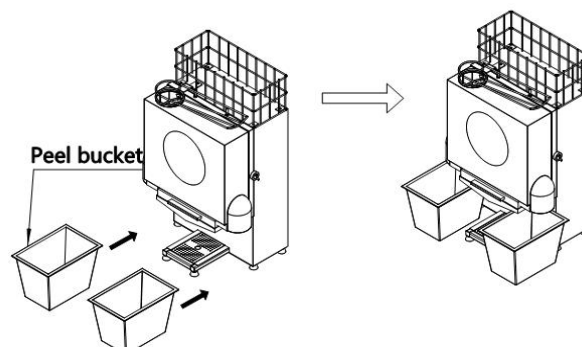

3. Pour the cleaned orange into the machine fruit basket.

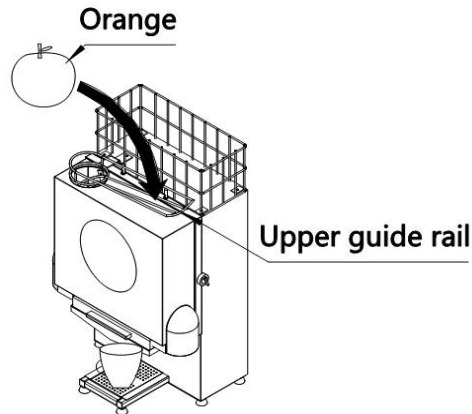

4. Switch on the machine and prepare it to work.

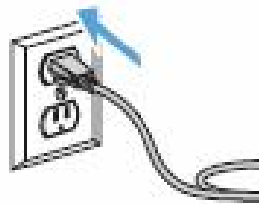

5. Press the start switch and start feeding artificially the orange continuously into the feeding port. After juicing is finished, the fresh juice will be discharged, and the fruit peel is automatically separated to enter into the fruit peel bucket.

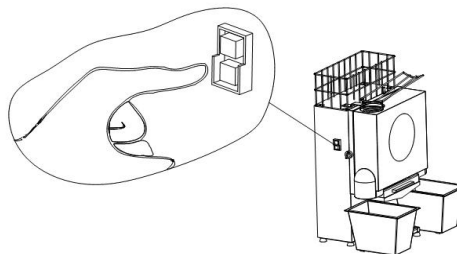

6. During the feeding process, please do not insert the fingers or other objects into the feeding port. If the juice storage container or the fruit peel bucket is filled up, switch off the power supply and then clean it.

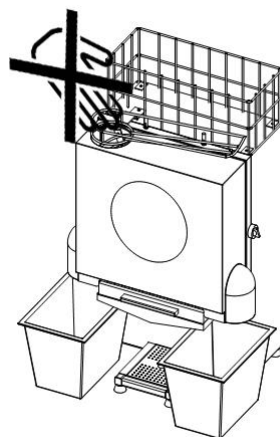

7. After the use of this machine is completed, turn off the switch and disconnect the power supply.

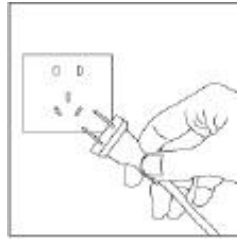

Maintenance and cleaning

1. Before cleaning the product, the start switch must be turned off, disconnect the power supply, wait until the machine stops completely.
2. Clean the product immediately after using.
3. The external of the main body can be wiped with wet cloth, please do not wash it with water directly and the unloaded parts can be directly put into the water to clean.
4. Refer the following the steps below to disassembly the parts to clean:
 - a) Unscrew the cover screw, take down the cover.

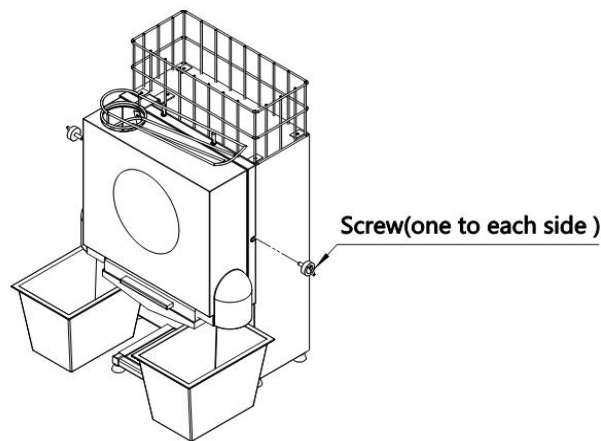

- b) In turn take down the knife combination (be careful the blade cutting hand), two groups of scraper combinations, unscrew the four screws, take down the two groups of concave and convex balls (each group of the concave and convex balls needed to be taken out at the same time).

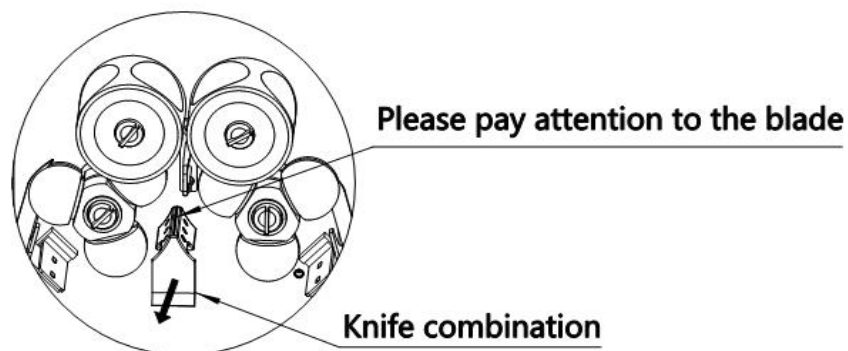

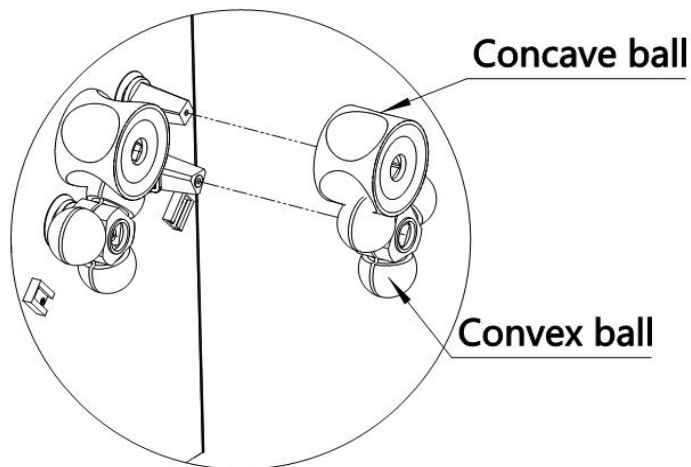
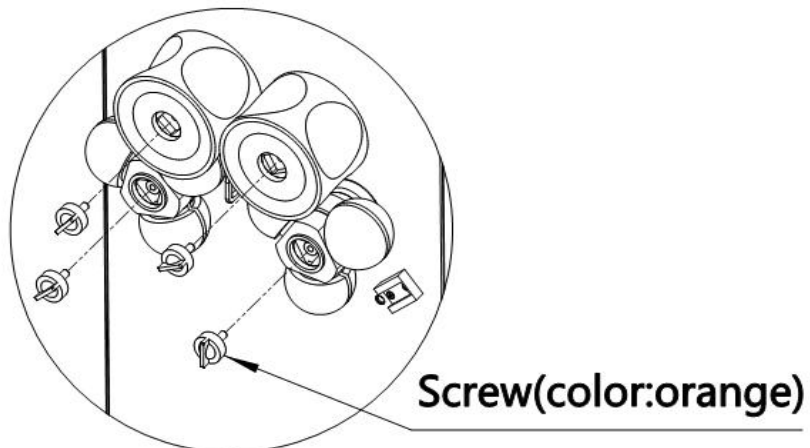
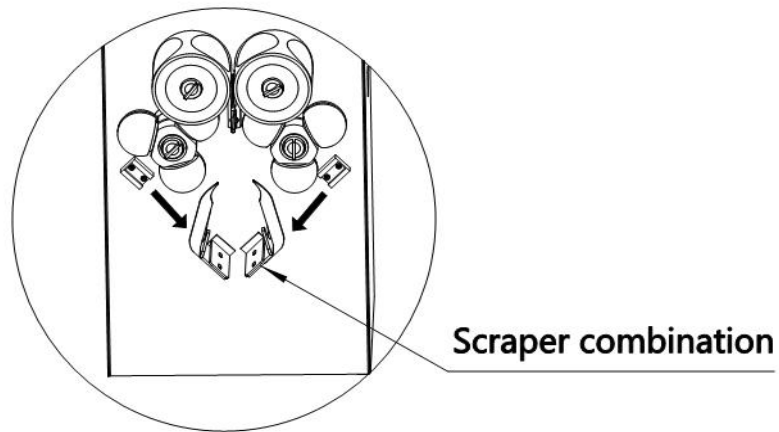

c) After the cleaning of the product is completed, re-install each part in the opposite order (especially pay attention whether the safety switch button is pressured).

Production troubleshooting and maintenance instruction

1. Electrical fault

A) The safety switch does not work:

1. Check whether the safety switch is in good condition;
 2. Check whether the safety switch is in the closed state.
- For models CLOJ-S120P20 & CLOJ-S120, pressure safety switch button form the top of the cover .

B) The starting switch does not work:

1. Check whether the starting switch is in good condition;
2. Check whether the starting switch socket end is plugged.

C) Motor does not work:

1. Check whether the socket at the two sides of the power line is tightened;
2. Check whether the fuse is in good condition;
3. Check whether the terminal in the motor switch box is solid connection.

2. Mechanical failure:

A) The motor output shaft end bevel gear wheel transmission mesh:

1. Check whether the size of bevel gear wheel is damaged;
2. Check whether the meshing positions of the big and small bevel gears wheel are correct, the adjustable small bevel gears wheel is rising to the correct meshing position and tighten the hex screws on the gear(when the small bevel gear wheel on the motor shaft position is moved down).

B) The damage of transmission cylindrical gear

1. The size of transmission cylindrical gear is divided into a pair of large cylindrical gear. ($Z = 52$), a pair of small cylindrical gear ($Z = 39$).
2. Iron gear is generally is tooth form damage.
3. If the cylindrical gear transmission has abnormal sound, it can be judged that the cylindrical gear is damaged, in the initial stage of the gear damaged, the machine work must be stopped immediately, the damaged gear must be replaced, otherwise it will affect the relative position of the working parts of machine, thus aggravates the damage of the gear, and until damage the electrical machine and the working surface of the and concave and convex balls.

Method of replacement of the cylindrical gear:

- A. Remove the damaged cylindrical gear and the elated parts according to the assembly sequence
- B. Use two square hole templates lock the upper two of four corner angle shaft parallels (figure 1), and then install two big cylindrical gears

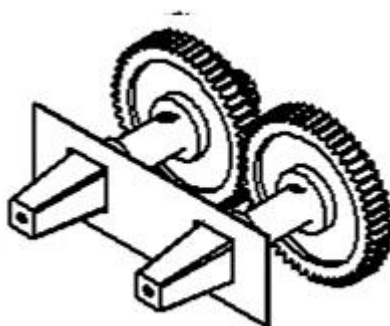

(figure1)

- C. Remove the two square hole templates.
- D. Use one square and a triangle template to lock the left (or right) upper four corner angle shaft and lower triangular shaft (figure 2) under the ridge axis, and then install the small cylindrical gear.



(figure 2)

E. The installation method of the other side of the small cylindrical gear is the same as D.



GGM Gastro International GmbH
Weinerpark 16
D-48607 Ochtrup

www.ggmgastro.com info@ggmgastro.com
+49 2553 7220 0