

ggm gastro

INTERNATIONAL

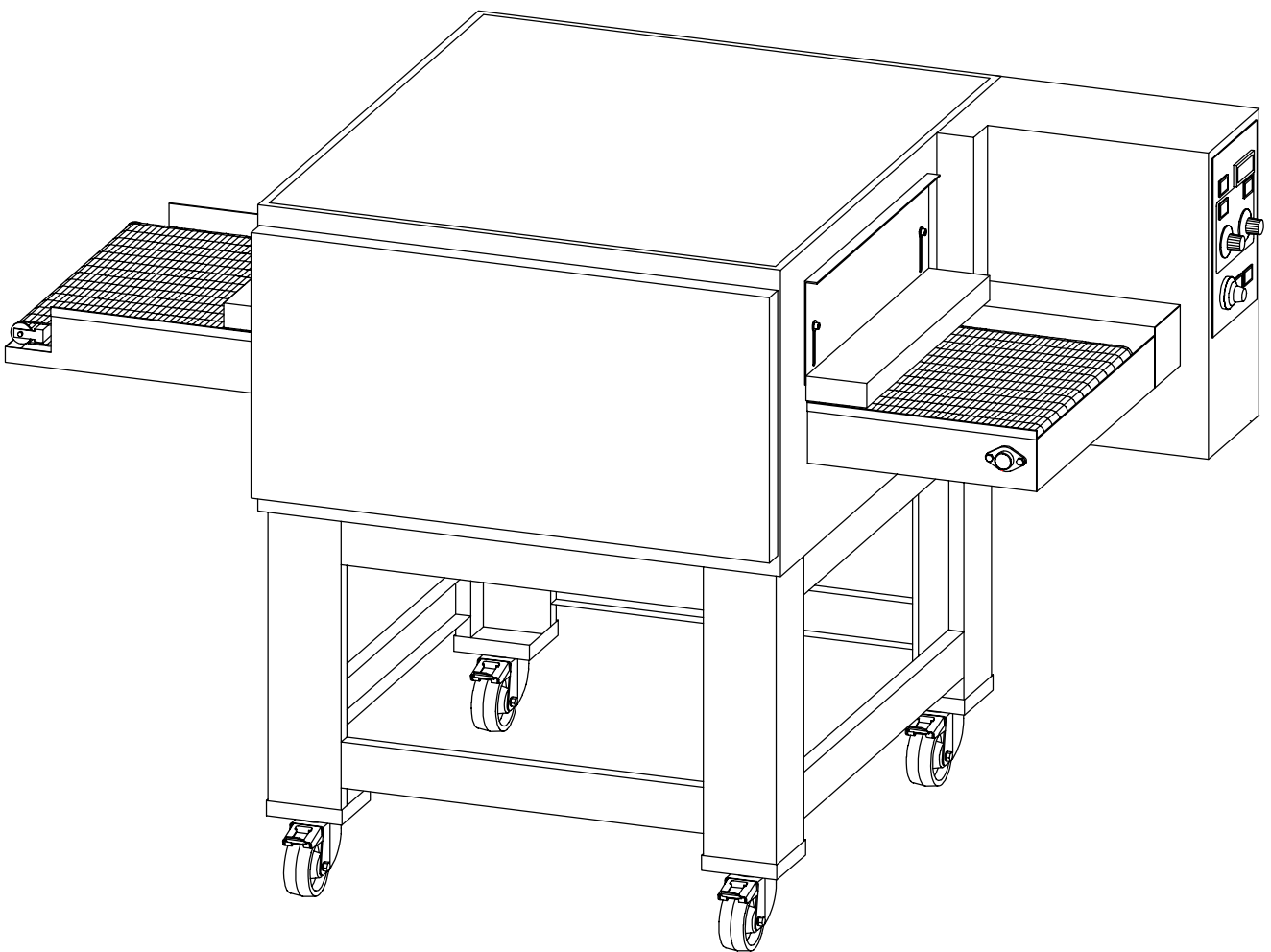









DPZ6030E

Electromechanical-Electronic

Tunnel convection oven
Installation, use and maintenance manual

INDEX

1. INTRODUCTION	3
2. HOW TO USE THIS MANUAL	4
3. SPECIFICATIONS	6
3.1 - PRODUCT IDENTIFICATION.....	6
3.2 - CONFORMITY TO DIRECTIVES.....	6
3.3 ENVISAGED USE.....	6
3.4 TECHNICAL SPECIFICATIONS.....	7
4. INSTALLATION WARNINGS.....	8
4.1 DELIVERY CHECKS	8
5. INSTALLATION.....	9
5.1 CHOICE OF PLACE OF INSTALLATION	9
5.2 ELECTRICAL CONNECTION.....	9
6. OPERATION – ELECTROMECHANICAL VERSION	11
6.1 CONTROLS	11
6.1.1 Temperature control	11
6.1.2 General.....	11
6.1.3 Power control.....	11
6.1.4 Conveyor belt	11
6.2 GENERAL WORKING	12
6.2.1  Luminous main ON/OFF switch.....	12
6.2.2  Resistors on switch	12
6.3 THERMOREGULATOR	12
6.3.1  Chamber temperature display.....	13
6.3.2  Set button	13
6.3.3  and  buttons	13
6.3.4  OUT indicator	13
6.3.5  FNC Botton	14
6.4 ERROR WARNINGS	14
6.4.1 Thermocouple short circuit	14
6.4.2 Thermocouple disconnected	14
6.5 POWER CONTROL	14
6.5.1 Power regulators	14
6.5.2 Oven top and bottom pilot lamps.....	15
6.5.3 Conveyor operating	15
6.5.4 Speed conveyor regulation.....	15

7.	OPERATION – ELECTRONIC VERSION	16
7.1	CONTROL PANEL	16
7.2	FUNCTIONAL STATES OF THE SYSTEM	17
7.2.1	Main on/off switch 	17
7.3	SETTINGS	18
7.3.1	Cooking time adjustment	18
7.3.2	Temperature adjustment	18
7.3.3	Top and bottom power adjustment	18
7.4	PROGRAMMING	19
7.4.1	Setting the current time	20
7.4.2	Setting the language.....	21
7.4.3	Programming of switching on	21
7.5	SWITCHING OFF THE OVEN	22
7.6	SAFETY PROCEDURES	22
7.6.1	“TEMP 1”	22
7.6.2	“TEMP 2”	23
7.6.3	“TEMP”	23
7.6.4	“MESH”	23
8.	USE.....	24
8.1	FIRST IGNITION.....	24
8.1.1	Electromechanical version.....	24
8.1.2	Electronic version	24
8.2	GENERAL COOKING INDICATIONS	25
8.3	SHORT PERIODS OF IDLENESS.....	26
8.4	EXTENDED PERIODS OF IDLENESS	26
9.	CLEANING	27
9.1	CLEANING OF ANY REMOVABLE PARTS	27
9.2	CLEANING OF EXTERNAL PARTS	27
9.3	CLEANING OF BAKING CHAMBER	27
10.	MAINTENANCE	29
10.1	ERROR WARNING.....	29
10.2	SAFETY THERMOSTAT	29
10.3	WIRING DIAGRAM.....	30
10.3.1	Electromechanical version.....	30
10.3.2	Electronic version	33
10.4	EXPLODED VIEWS AND LIST OF SPARE PARTS	36
11.	DECOMMISSIONING AND DEMOLITION.....	46

1.INTRODUCTION

The **GGM** oven, in its **DPZ6030E** versions, is part of a family of conveyor belt ovens which have been primarily designed for the automatic cooking of pizzas and similar products. The special characteristic of the oven is that it is possible to carry out excellent cooking without the need to check on the cooking. The result is that the cooking processes can be put in the hands of unskilled staff.

These advantages are reinforced by the fact that the **GGM** oven, version **DPZ6030E**, comes into the family of ventilated ovens. The circulation of air in the cooking chamber means it is possible to achieve more even and repeatable cooking ,thus further simplifying the tasks of the operator. The **GGM** oven, versions **DPZ6030E**, is thus particularly efficient and by suitably controlling the air circulation the product will not dry out and retains all of its flavour.

GGM thanks you for choosing one of our ovens. We at GGM can assure you that you have made a good choice as we have been making quality products for decades now and have never engaged in counterproductive penny-pinching in our selection of the best available materials.

2. HOW TO USE THIS MANUAL

 The paragraphs with this symbol contain essential safety information. They must all be read both by the installers and by the final user and any of his staff who may use the equipment. GGM shall not be held liable for any damaged which may occur as a result of failure to observe the norms indicated in these paragraphs.

 The paragraphs with this symbol contain important information that can be used to avoid damage being caused to the equipment. It is the user's own interest also to read these paragraphs carefully.

 This manual should be kept near to the equipment itself so that it can be quickly and easily consulted. The manual must travel with the equipment if it is moved to another owner as the latter may not be considered complete or safe without it.

Please take note of the code and revision numbers which are behind the back cover. If this copy should get mislaid or destroyed you can order another one by referring to the codes.

 This manual is divided up into a number of chapters. All of these should be read by the installers, maintenance staff and the final user, both in relation to its **safe use** and in order to obtain the best results from this product.

Despite this we also give below some useful indications on how to look things up quickly in the various chapters.

Chapter 3 contains a description of the oven's characteristics and all the figures which may be needed when choosing, installing and using it. It should be used as a reference to check the use which is intended to be made of the equipment corresponds to that for which it was designed, and whenever it is necessary to know an exact size value relating to the equipment.

Chapters 4 and 5 provide all the information necessary for the installation of the oven. They have been primarily written for specialised staff but may be read in advance also by the final user to prepare and

set up the space and plant necessary for the proper working of the equipment.

Chapters 6 and 7 help the operator to switch on, use and switch off the oven in safety conditions.

Charter 8 includes use advices.

Chapter 9 provides all the information required for the cleaning of the equipment i.e. all those operations which have to be carried out by the user in order to ensure that the equipment continues to function safely (especially from the point of view of hygiene) and generally obtains the best results at all times.

Chapter 10 provides the information necessary for proper periodic and extraordinary maintenance e.g. repairing or replacing parts of the equipment.

This chapter has also an exploded view of the equipment and list of spare parts to make ordering and replacing any damaged part easier.

Chapter 11 gives directions for dismantling the oven.



These maintenance operations must be carried out by specialised staff.

3.SPECIFICATIONS

3.1 - PRODUCT IDENTIFICATION

This is the manual for the conveyor belt ovens GGM DPZ6030E

3.2 - CONFORMITY TO DIRECTIVES

The GGM ovens DPZ6030E bear the following compulsory mark:



which indicate their conformity to the following European directives:

89/392 CE machines
89/336 CE electromagnetic compatibility
2006/95 CE low voltage

3.3 ENVISAGED USE

The GGM DPZ6030E ovens have been designed to cook pizzas and similar products. The GGM DPZ6030E ovens are intended for use in the catering industry (restaurant, pizzerias, etc.) and **for professional use by trained staff.**

The operations envisaged in normal use of the cooking modules are the loading and unloading of products from the cooking belt, switching on, regulation, switching off and cleaning of the whole equipment.

3.4 TECHNICAL SPECIFICATIONS

The table below show the technical specifications of the bake unit.

	DPZ6030E	Units of meas.
Weight	165	Kg
Base weight	190	Kg
Overall dimensions	1210x1720x570	mm
Overall dimensions with base	1210x1720x1105	mm
Conveyor belt width	500	mm
Conveyor belt length	1690	mm
Chamber length	850	mm
Production capacity	12,5 (50-60 pizzas Ø 30 cm)	Kg/h
Electrical feed	three-phase	
Voltage	400-3N / 230-3 / 230-1	VAC
Frequency	50 o 60	Hz
Current	22 / 40 / 61.5	A
Total electrical power	14.5	Kw
Electrical connection	plugless 5 lead cable	
Cable length	2	m
Section of lead wires	6	mm ²
Cooking control	computerised electronic	
Unit of measurement temperature		°C
Maximum temperature which can be set	320	°C
Error warnings	by display	
Ambient conditions		
Temperature	0 - 40	°C
Maximum humidity	95% without condensation	

Table 3-1 - Technical specifications

4. INSTALLATION WARNINGS

 **WARNING:** These installation instructions are intended only for staff which is qualified for the installation and the maintenance of electrical and/or gas plant. Installation by any other person may cause damage to the equipment, persons, animals or things.

Furthermore where, to install the equipment, it is necessary to make any modifications or additions to the electrical plant in the building in which the equipment is being installed, the works must be certified as having been carried out in accordance with proper practice.

4.1 DELIVERY CHECKS

Unless otherwise agreed the products are carefully packed in a strong wooden crate with a blister sheet of nylon to protect them from shocks and humidity during transit and are delivered to the forwarder in the best possible condition.

We recommend, however, that the packaging is checked on arrival to ensure that there are not visible signs of damage. If there are any such signs indicate their nature on the receipt which has to be signed by the driver.

Once the equipment is unpacked check to see if it has suffered any damage. Also check that any parts which are delivered unattached to the equipment are present. If there has been any damage to the equipment and/or any parts are missing do not forget that the transport company will accept complain only up to 15 days from the delivery and that GGM will not be held liable for damage suffered to its products during transit. We have nevertheless willing to help you in presenting your complaint.

 If there is any damage do not attempt to use the equipment and call upon professionally qualified staff.

5. INSTALLATION

5.1 CHOICE OF PLACE OF INSTALLATION

The good, safe and long working of the equipment also depends on the place in which it is installed so it is advisable to carefully evaluate this before it is delivered.

Install the equipment in a dry place which is easily accessible both as regards its use and its cleaning and maintenance. The area around the equipment must be free of encumbrances. In particular it is necessary to avoid obstructing the cooling apertures.

The equipment must in any case be installed at least 20 cm from the walls of the room and from other equipment.

 Finally it is necessary to ensure that the temperature and relative humidity of the place in which the equipment is installed must never exceed the maximum and minimum values indicated in the characteristics section (see 3.4). In particular if the maximum temperature and relative humidity are exceeding the equipment may easily and unpredictably go out of order or be damaged in its electrical parts, thus creating a dangerous situation.

5.2 ELECTRICAL CONNECTION

 The equipment is supplied with a cable for the electrical connection with earth lead. In observance of the current safety norms **it is compulsory to connect the earth wire (yellow-green) to an equipotential system whose efficiency must be properly checked against the norms currently in force.**

 Before making any connection ensure that the characteristics of the mains supply to which the equipment has to be connected, corresponds to the feed characteristics required by the equipment itself (see table 3-1).

The feed cable must end in a plug which connects to an electrical feed panel with a corresponding socket and a differential magneto thermal switch.

The plug-socket must be such that the earth lead is connected first and disconnected last and must be of the correct size for the nominal current (See table 3.1). Suitable plugs and sockets are the industrial type CEE17 of any which satisfy the European norm EN 60309.

The thermal safety device must be set for the total nominal current, the magnetic safety device must be set for the instantaneous maximum current (in the case of ovens it is a little above the nominal figure) (see table 3.1), while the differential device must be set to the 30 mA current (see 3.).

GGM shall not be liable for any damage which results from failure to observe the above mentioned norms.

6. OPERATION – ELECTROMECHANICAL VERSION

6.1 CONTROLS

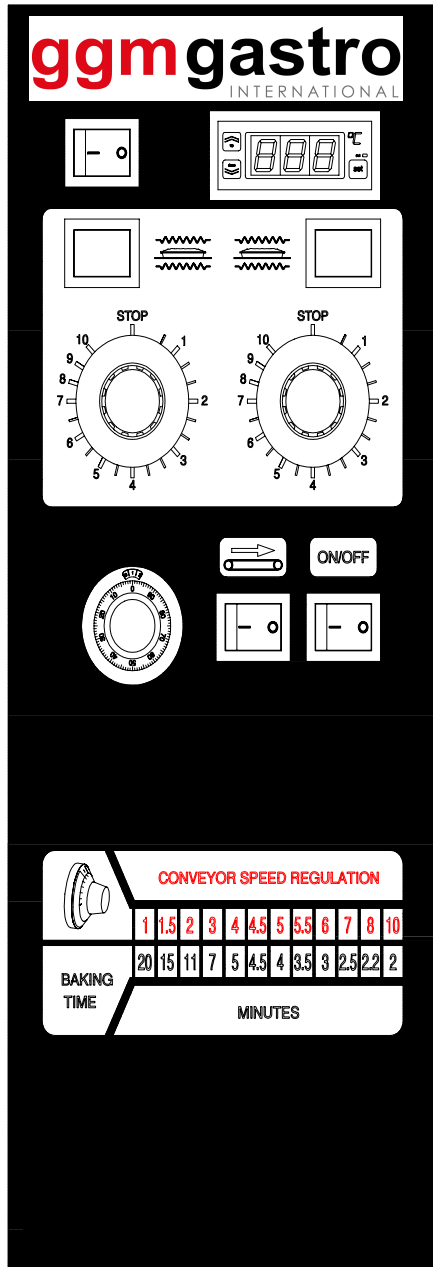

6.1.1 Temperature control

Chamber temperature display

Set button

Up button

Down button

Out indicator

ESC button

6.1.2 General

Luminous main switch

6.1.3 Power control

Luminous resistors on switch

Warning light and oven top energy regulator

Warning light and bottom energy regulator

6.1.4 Conveyor belt

Switch enabling conveyor belt motor

Knob for adjusting the conveyor belt speed

6.2 GENERAL WORKING

To identify the controls described below refer to figure 7-1, chapter 7.

6.2.1 Luminous main ON/OFF switch

When this switch is in the OFF position all of the indicators on the control panel are off. When it is in the ON position the switch itself and the thermoregulator are on, so that it is possible to program the temperature. The heating elements in the chamber remain off while the on/off switch is off.



6.2.2 Resistors on switch

When this switch is in position 0 the cooking chamber stays off, irrespective of the temperature and power programmed. When put in the 1 position the switch itself lights up and heating elements in the cooking chamber switch on according to the temperature and the power set.

6.3 THERMOREGULATOR

On the thermoregulator panel there are four push buttons. and a red led.

The °C display indicates the effective cooking chamber temperature and the OUT indicator.

The increase  and decrease  push buttons are used to set the desired temperature at any time. A short press on one of the buttons increases or decreases the temperature set by 1° C. If the button is held down for longer, the temperature set increases or decreases, at first slowly and then more quickly.

If the red led is on it indicates that the thermoregulator needs heat to reach the set temperature.

⚠WARNING. If the red led lights up during this setting up stage it may cause the resistors to go on. If this result is not desired, before switching on the main switch ensure that the  switch is in the OFF position .

Starting from an effective temperature which is below that point set, the thermoregulator keeps on asking for heat (red led on) until the effective temperature exceeds that set by 1°C. At that point the red led and the resistors switch off at the same time and go on again when the effective temperature is 1°C lower than the set temperature.



6.3.1 Chamber temperature display

In the temperature programming mode this display shows the programmed temperature. When the light at the side goes out it indicates that the set temperature has been reached. This display is also used to warn of errors.

6.3.2 Set button

Press this button to enter into temperature programming mode.

 **WARNING.** Do not keep this button pressed as it may change the thermo regulator's internal parameters which may lead to unpredictable malfunctions.

In this function mode the display 000 shows the programmed temperature which can be varied using the  and  buttons. If the buttons are not pressed for more than three seconds the thermo regulator automatically returns to normal mode of functioning. For the temperature fields which can be set, see chapter 8.

6.3.3 and buttons

By pressing and releasing these buttons once the set temperature increases or decreases, at first slowly and then more quickly.

6.3.4 OUT indicator

The  indicator comes on when the chamber temperature falls below the set temperature. It goes off when the set temperature is reached and goes on again when the temperature falls 1°C below the set temperature.

When the  **indicator** is on the elements heat up in the cooking chamber in accordance with their power settings.

6.3.5 **FNC Botton**

Press this push button to quit from the temperature programming mode.

6.4 ERROR WARNINGS

The electronic thermo regulator may signal errors in functioning as described in the paragraph below.

6.4.1 Thermocouple short circuit

When the thermocouple is in short circuits, the display  shows “---”.

6.4.2 Thermocouple disconnected

When the thermocouple is disconnected or there is a break the 000 display shows “EEE”.



The same error code also appears if the chamber temperature is above the maximum set temperature.

6.5 POWER CONTROL

Each cooking chamber has two power regulators, one connected to the oven top heating elements, and other to the bottom heating elements. These regulators ensure an even distribution of the inside the cooking chamber so as to obtain an even cooking.

6.5.1 Power regulators

Each power regulator controls the power of its own heating element, regulating the start up time of the heating element within a range of 30 seconds.

If the power regulator is set on 1, its heating element will be on for 3 seconds and off for 27 seconds (provided the  is on). If the power regulator is placed on 5, its heating element is on for 15 seconds and off for 15 seconds. When the power regulator is placed on 10, its heating element is always on (provided the  display is on).

6.5.2 Oven top and bottom pilot lamps

Both oven top and bottom pilot lamps turn on when the ^{out}  display is on and its power regulator is switching on within the regulation cycle, to indicate that its heating element is actually on.

6.5.3 Conveyor operating

If you put the red switch positioned under the sign  the conveyor starts to operate.

6.5.4 Speed conveyor regulation

The knob of the speed conveyor regulation  allows to set the baking times values according to the table placed under the regulator.

In the small window you can read the whole numbers of such value, while on the round side of the knob you have the decimals.
The regulator small lever allows to lock or unlock if you turn it respectively clockwise or counter clockwise.

7. OPERATION – ELECTRONIC VERSION

7.1 CONTROL PANEL



Oven on-off key



Parameter value decrease key



Programme access key



Parameter value increase key



Mesh start/stop key



Automatic switching on-off key

7.2 FUNCTIONAL STATES OF THE SYSTEM

7.2.1 Main on/off switch

In the off position there is power in the system but none of the individual functions work as the main contactor is deactivated.

All the outputs are de-energized except the ones for programming.

The display indicates "OFF", the current time and the day and time the oven will next be automatically switched on.

The day is written as follows:

OFF	00:MM
Start: ddd	oo:mm

where:

OO = current hour

MM = current minute

ddd oo:mm = day, time, minute the oven is automatically switched on.

The day is written as follows:

Monday

Tuesday

Wednesday

Thursday

Friday

Saturday

Sunday

When the oven is off, the rear illumination on the display is also off.

This turns on when programming is started.

In the ON position the main contactor is activated, the fan turns on and the oven heats up. The display is illuminated from behind and indicates:

XXX°C	mm:ss

where:

XXX°C = Cooking temperature

mm:ss = Cooking time in minutes and seconds

--- = Operating condition of burner (Max =high flame, Min = low flame, --- = flame off).

7.3 SETTINGS

7.3.1 Cooking time adjustment

The desired cooking time is set directly by the user, relating to the relative speed of mesh progress automatically controlled by the electronic circuit board.

When the oven is switched on, the mesh is inactive and the cooking time flashes on the display.

Press the mesh start/stop key  to activate the mesh.

Mesh movement can be activated or deactivated at any time

using the key .

When the mesh is inactive, the cooking time flashes.

When the oven is on, the mesh can be manually adjusted to

reach maximum speed by pressing the key  for 4 seconds.

Press the same key again to return to the previous setting.

See the “programming” paragraph to set the cooking time.

7.3.2 Temperature adjustment

The oven temperature can only be adjusted when the oven is on.

The oven heats up to and then remains at the set temperature until it is switched off.

When the oven is on, the real temperature of the cooking chamber is indicated; press the parameter value increase key

 to display the set temperature.

See the “Programming” paragraph to learn how to adjust the set temperature.

7.3.3 Top and bottom power adjustment

To heat up of the oven , modulate the ignition of the top and bottom heating elements according to the selected power percentage, as explained hereunder.

The modulation consists in the ignition of the heating elements for a fixed time, on a period of 45 seconds in total.

For example if the value 20% is selected, the heating elements will be fed cyclically for 9 seconds each 45.

To avoid that heating elements are switched on at the same time, the top elements are on at the beginning of the period, while the bottom elements are on at the end.

For instance, if the value 30% is selected for the top heating elements, and the value 20% is selected for the bottom heating elements, the working cycle is effected as shown below:

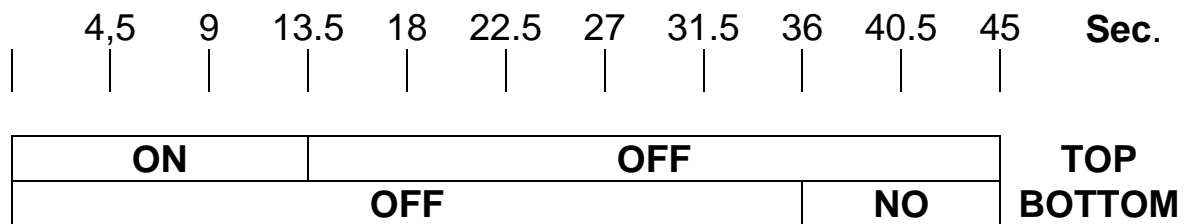

On the display you can read the percentage of ignition of the heating elements (CC%=top heating elements, left / PP%=bottom heating elements, right)

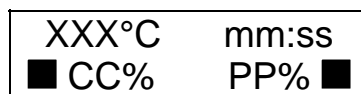

When the heating elements are switched on, on the display the indicator (■) is shown.

If the value 0% is selected, the relevant group of heating elements never turns on.

See the paragraph “Programming” to learn how to set the power parameters of top and bottom heating elements and how to set the cooking time.

7.4 PROGRAMMING

The operating parameters programmed by the user are:

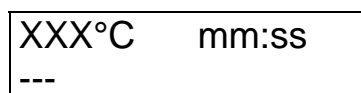



where:

- cooking time (mm:ss)
- set temperature (XXX°C)

These parameters are normally indicated on the display when the oven is on and can be set with the oven on or off.

Press the programming access key  to enter programming mode and move from one parameter to the next.

The parameter being programmed flashes on the display in a horizontal line at the bottom.

To change the value, use the keys  to increase and  to decrease.

By keeping the key pressed you increase the speed of data change.

If no key is pressed for more than 5 seconds, the displayed value is memorised and the oven automatically leaves the programming mode.

During programming the keys  and  are deactivated.

The order of programming is as follows:

- 1) Cooking time
- 2) Temperature

7.4.1 Setting the current time

The current time can be set by the user when the oven is on or off.

Press the key  for 3 consecutive seconds to access the setting.



The display indicates:

PROG. OROLOGIO GG-MM-AA oo:mm

where:

- GG = current day
- MM = current month
- AA = current year
- oo = current hour
- mm = current minute

A cursor indicates the data being modified.

The value can be adjusted using the keys  and . Then

confirm by pressing the key  and move to the next item of data.

After setting the day, month, year, hour and minutes, press the key  to move to programming the current day of the week. The following box:

PROG. OROLOGIO DDDDDDDDD

appears on the display, where:
 DDDDDDDDD = current day of the week.

7.4.2 Setting the language

The display language can be chosen from a list of available options.

To set the language, enter the clock programming mode (see setting the clock) and confirm the data until:

SELEZIONA LINGUA ITALIANO

appears on the display.

Adjust and confirm using the same procedure adopted for setting the clock.



By confirming you leave the programming mode and return to the previous mode.



7.4.3 Programming of switching on

To access the settings for the programmed switching on, press



and immediately release the key  with the oven on or off.





At first the state of the automatic switching on (active or inactive) appears on the display (AUTOSTART : ON or OFF).



Press the keys  or  to activate or deactivate the programmed switching on.

After activating with the key , press the key  and the day and time appear on the display. To select the switching on time,

position the flashing cursor under the time using the key 

and then press keys  or  to set the value. If the oven is not required to be switched on a certain day (e.g. closing day),

select the off option between 23 and 00 while setting the time using the keys  or . Press the key  again to move to minutes and press the key  once again to bring the cursor back to the day of the week.

To move to the next or previous day press the keys  or .

When the setting is complete, press the key  again and wait for about five seconds. The data is automatically memorised and the oven returns to the previous function.

When the oven is off, the day and time of the switching on appears on the display to indicate that this function is on. The word “off” appears instead of the day and time if the function is not activated.

7.5 SWITCHING OFF THE OVEN

Press the key  to switch off the oven.

The heating stops while the air recycling fan and mesh continue working, if on, until the temperature drops below 150°C. After this the main contactor de-energizes leaving only the circuit board powered to feed the clock and programmed switching on functions.

During the switching off phase the rear illumination remains on and the word “OFF” flashes. During this phase the oven can be switched back on and the mesh can be started or stopped.

To prevent the oven being accidentally switched on, check the display indicates the precise desired day and time of switching on, or, if automatic switching on is not desired, that the words “start: off” appear.

7.6 SAFETY PROCEDURES

The functioning of the oven is continually checked, setting off an alarm procedure if any faults arise.

7.6.1 “TEMP 1”

If the temperature measured by probe 1 exceeds 350°C or if the probe breaks, the temperature value on the display is replaced by the flashing phrase “TEMP 1” and the alarm intermittently sounds.

Switch off the alarm by pressing the key .

The oven continues working and only probe 2 is used to measure the temperature. The control temperature is also automatically decreased by 40°C.

This variation in the temperature corrects the only value read in the hottest part of the oven and simulates an approximate value to the effective value which was previously set by supplying the average of values between the hottest and coldest points. This allows the oven to be used even when a probe breaks.

7.6.2“TEMP 2”

If the temperature measured by probe 2 exceeds 450°C or if the probe breaks, the temperature value on the display is replaced by the flashing phrase “TEMP 2” and the alarm intermittently sounds.

Switch off the alarm by pressing the key .

The oven continues working and only probe 1 is used to measure the temperature. The control temperature is also automatically raised by 40°C.

This variation in the temperature corrects the only value read in the coldest part of the oven and simulates an approximate value to the effective value which was previously set by supplying the average of values between the hottest and coldest points. This allows the oven to be used even when a probe breaks.

7.6.3 “TEMP”

If the temperature measured by probe 1 exceeds 350°C and probe 2 exceeds 450°C at the same time, the temperature value on the display is replaced by the flashing word “TEMP” and the alarm sounds intermittently.



Switch off the alarm by pressing the key .

7.6.4 “BELT”

When the mesh motor is broken or sends wrong signals to the circuit board, the word “BELT” flashes on the display and the alarm sounds intermittently.



This means that the cooking time does not correspond to the set value and that specialized personnel are required to reset the functions of the oven.

8.USE

 During cooking or at the end of cooking some of the oven's surfaces reach dangerous temperatures. The  symbol warns of this danger. Never touch these surfaces and only use the proper handle.



8.1 FIRST IGNITION



8.1.1 Electromechanical version

 Before giving electrical input to the oven, it is necessary to make sure that the main switch  and the heating elements start switch  are in OFF position.



Position the main switch  on the ON position, and in this way the fan starts. Position the power regulators on the desired value.

Select on the thermo-regulator the desired temperature.



Position the switch  on position 1 and set the net speed regulator  to about half (0 on the rotating graduated scale and 5 on the small window).



Position the heating elements start switch  on position 1. Once the oven has reached the selected temperature, before baking the product, it is necessary to set the desired baking time. To do this, verify the list (which is also present on the control panel) the conveyor speed corresponding to the baking time needed and rotate the handle .



8.1.2 Electronic version



 Before connecting the oven to the electrical main, be sure that the main switch  is positioned on OFF.

Position the switch  on the ON position; the fan is activated.

Select the desired cooking time by pressing the push-button  then adjust it as required by pressing the push-buttons  and .

Now press the push-button  and select the desired temperature by means of the buttons  and  then confirm.

Select  to adjust the oven top power by means of the buttons  and , then confirm.

After having adjusted the top power, select  to adjust the bottom power by means of the buttons  and , then confirm.

After having chosen the cooking time and temperature, start the conveyor by pressing the relevant push-button .

8.2 GENERAL COOKING INDICATIONS

It is not possible to say exact times and temperatures for food products in general given the enormous variations they are subject to.

As regards pizzas and similar products in particular the cooking time and temperature depend on the shape and thickness of the dough and the quantities of the ingredients added to it.

We therefore advise that a few test runs are made, especially if you have never worked with this model of oven before, starting out with a temperature of 290/310°C and keeping in mind the following points:

1. generally much lower temperature for similar cooking times are required than for static ovens.
2. with lower temperatures a better quality and more digestible product is obtained, the oven is not subjected to particular stresses and lasts longer, though the cooking times become longer.
3. with higher temperatures it is more difficult to obtain even cooking but the cooking times are reduced.
4. the oven has a maximum production capacity which is **indicatively** expressed in kg of product per hour. If this production capacity is exceeded, the cooking chamber temperature falls even beyond 10-20°C. If this happens remove the excess quantities and wait for the temperature to be reached again before next loading the oven.

8.3 SHORT PERIODS OF IDLENESS

When there are no products to bake, but you want to keep the temperature, it is advisable to low the power regulators in minimum position. In this way, specially if the selected temperature is over 300°C., it is possible that the chamber temperature slightly decreases, but very slowly. This is not a problem, as turning again the power regulators in maximum position, in a short time the oven will reach again the selected temperature and it will be possible to bake the products again.

8.4 EXTENDED PERIODS OF IDLENESS

When the oven is not used for a long period, you must position the switches ON/OFF in off position. For longer periods of inactivity (for instance holidays closure) it is advisable to turn off the main switch on the electric panel, but only when the chamber's fans have stopped.

9. CLEANING



Cleaning should be carried out with the equipment switched off and at room temperature and after having switched off its electrical supply with the button on the feed panel.

9.1 CLEANING OF ANY REMOVABLE PARTS



After washing any removable parts it is also necessary to use a water jet on the points at which they connect with the equipment and the corresponding supports so as to prevent the accumulation of dirt or detergent residues which could contaminate the products.



It is also not advisable to use abrasives (abrasives sponges and such like) as they may in the long term diminish the shine of stainless steel parts and of glass. It is better to wash the various removable parts before the food residues are dry.

9.2 CLEANING OF EXTERNAL PARTS

Use a soft wet sponge with a light not abrasive detergent, to clean the stainless steel or painted external parts and the control panels.



Do not use abrasive or corrosive detergents, as they would damage the stainless steel and the painted parts.



Do not use jets of water, as they could penetrate the switchboard and create a danger of electrocution and/or sudden start-up of the equipment.

9.3 CLEANING OF BAKING CHAMBER

To clean backing chambers in stainless steel, follow the instructions below 9.2. To reach the inside parts of the backing chamber, first of all switch off the oven, then operate as follows.

Remove the inlet “25” and exit “26” drawer from the conveyor frame”38”.

Remove the fixed enclosure “11”, moving it upwards.

Turn manually the conveyor until the shaft pin “34” coincides with the joint notch “41”.

Unloose first the counter nut and then the joint fixing screw, using a 10 key; let the joint slide towards the conveyor bench “41” disengaging the joint parts.

Lift up the entry and exit lower diffusers “24” at max. opening.

Lift up the conveyor bench “38” from both sides and move it towards the control side.

Open the serigraph. panel “1” and, using a pair of strong gloves to avoid accidents, disengage the diffusers “3” and “19” from the supports which are near the door, turning upwards; then bring the diffusers towards the centre of the door and remove it.

In case of model DPZ6030E, the diffusers are not engaged but they are fixed with hexagon nuts; use a 10 key to unscrew the nuts.

To clean the disassembled parts see chapter 9.1; to clean the backing chamber inside, remove the accumulation of dirt with a burst and a dustpan or use a vacuum cleaner; clean the metal surfaces with a sponge steeped in water or non abrasive - corrosive detergents then rinse the surfaces with a damp sponge. At the end of cleaning remount all the components in opposite sequence to the above mentioned description.

It is advisable to clean the backing chamber every 200 operating hours.

10.MAINTENANCE

 **WARNING:** these use and maintenance instructions are intended only for a staff qualified for the installation and maintenance of electrical and gas equipment. Maintenance by other persons may cause damage to the equipment, persons, animals or things.

 In the majority of cases it is necessary to remove the fixed guards in order to carry out repairs and checks. This also renders the voltage cables accessible.

Before carrying out any maintenance operations check that the equipment's feed cable plug is disconnected from the switchboard. Put the plug in a place where the maintenance operator can easily ascertain, during all of the work done with the guards removed, that it has been disconnected.

10.1 ERROR WARNING

Electronic controls is able to identify some malfunctions, for details see paragraphs 7-6.

10.2 SAFETY THERMOSTAT

The safety thermostat intervenes when the temperature in the chamber goes above 500°C and de-activates the resisters. The safety thermostat is located on the outside of the switchboard under the conveyor belt.

To correct the error unplug the feed panel and wait for the chamber to cool down.

Unscrew the cap of the safety thermostat reset button and press the button. Resetting is not possible until the temperature in the chamber has fallen below 500°C.

Since the safety thermostat only intervenes where there are serious malfunctions, carefully check the oven's working and repair if necessary before starting up the oven again.

10.3 WIRING DIAGRAM

10.3.1 Electromechanical version

Figures 10-1, 10-2, show the wiring diagrams of the conveyor oven mod. DPZ6030E Power in electromechanical version.

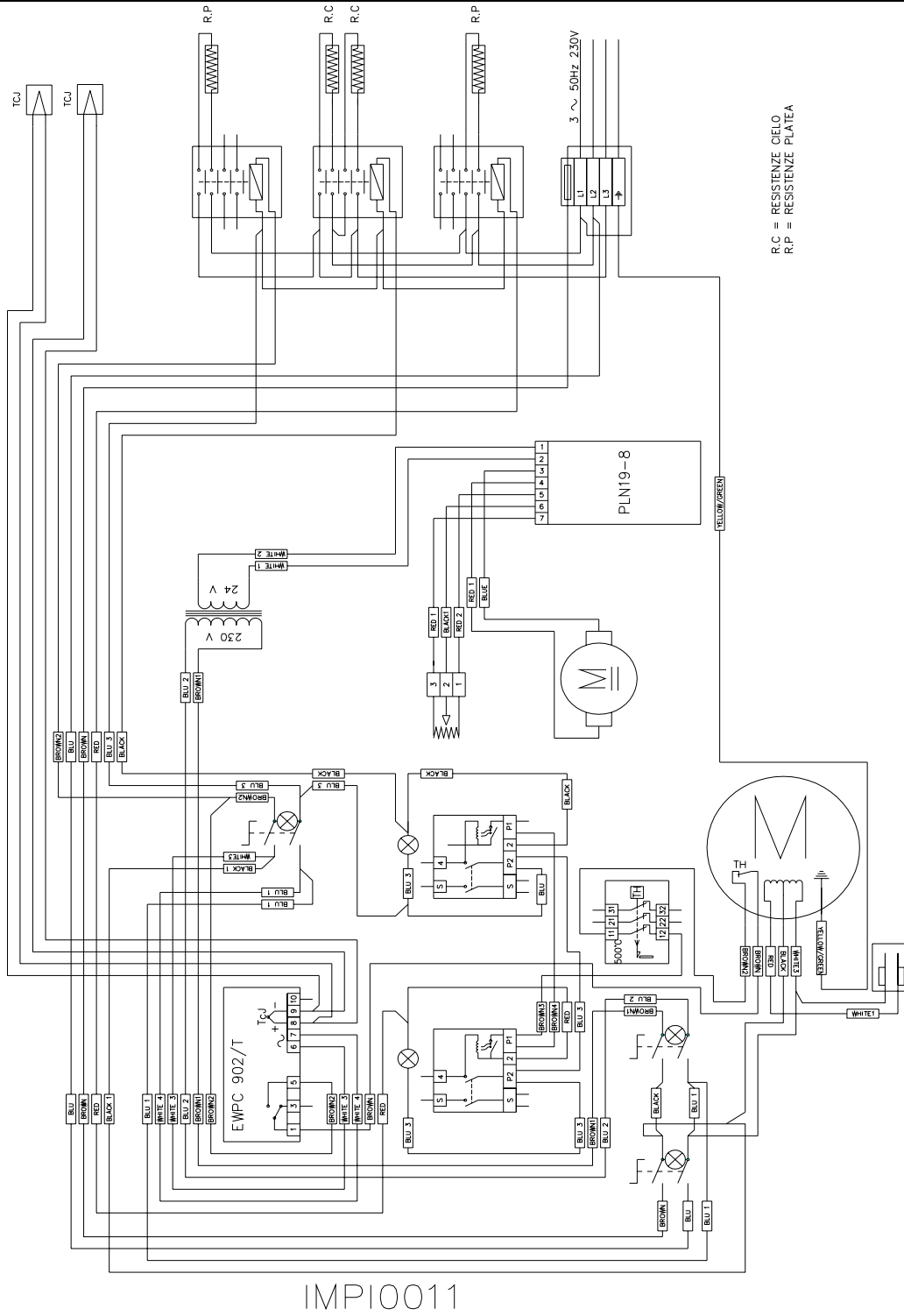
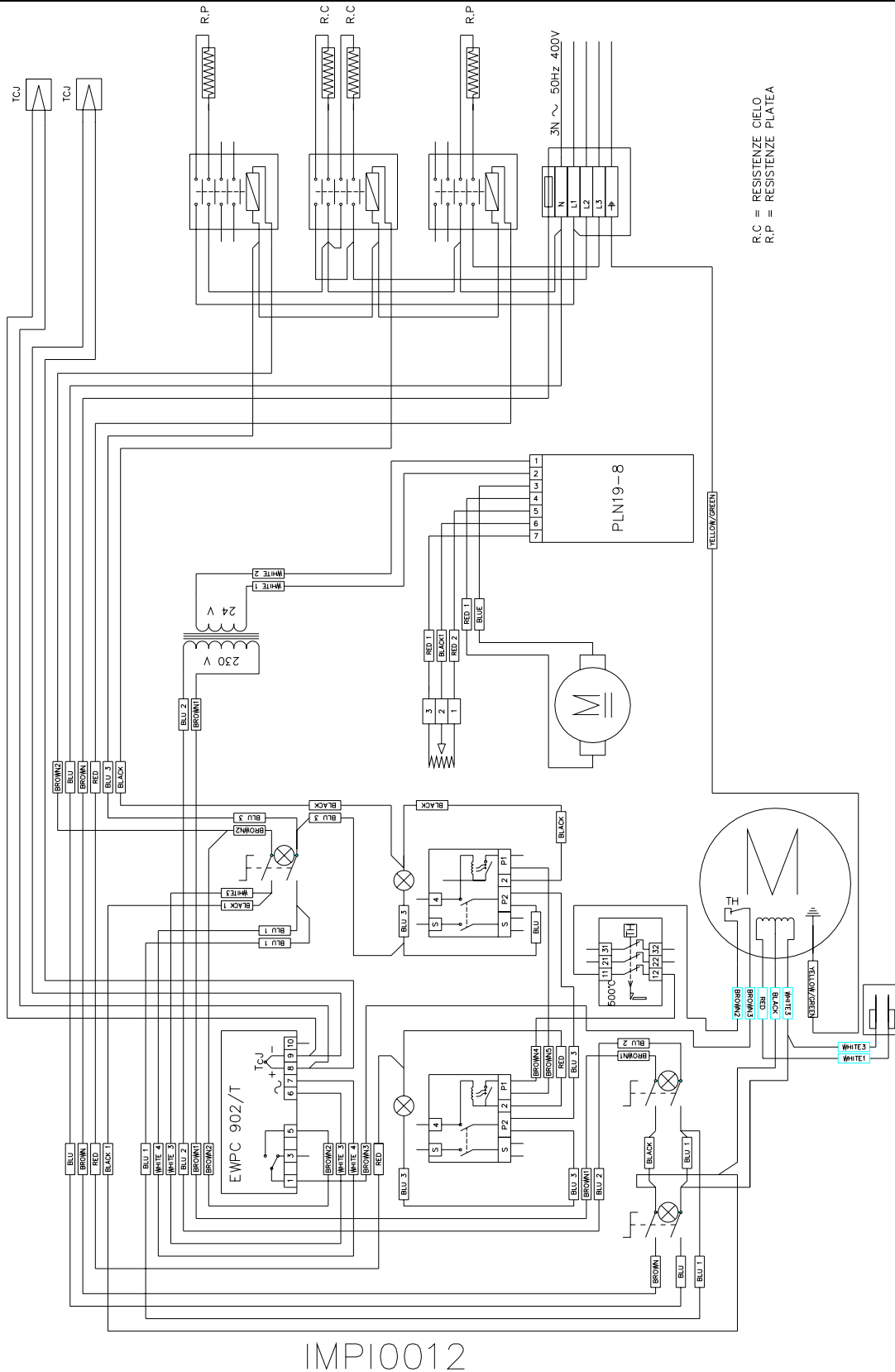

Fig. 10-1. Wiring diagram DPZ6030E - 230 Vac. 3 50-60Hz



R.C = RESISTENZE CIELO
R.P = RESISTENZE PLATEA

Fig. 10-2 Wiring diagram DPZ6030E - 400 Vac. ~ 3+N 50-60Hz

10.3.2 Electronic version

Figures 10-3, 10-4 show the wiring diagrams for the conveyor oven mod. DPZ6030E in electronic version.

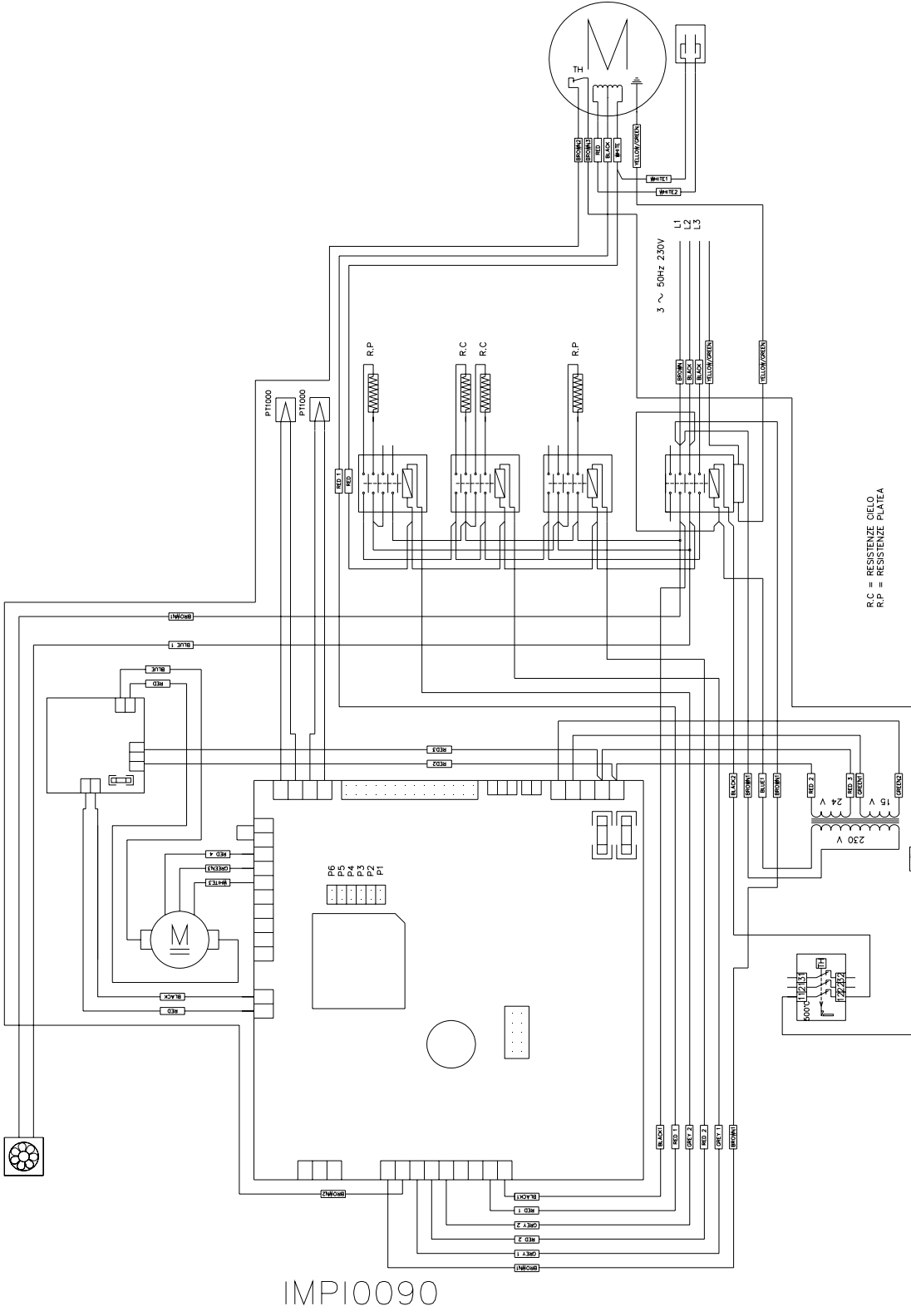

IMPI0090

Fig. 10-3 Wiring diagram DPZ6030E - 230 Vac. ~ 3 50-60Hz

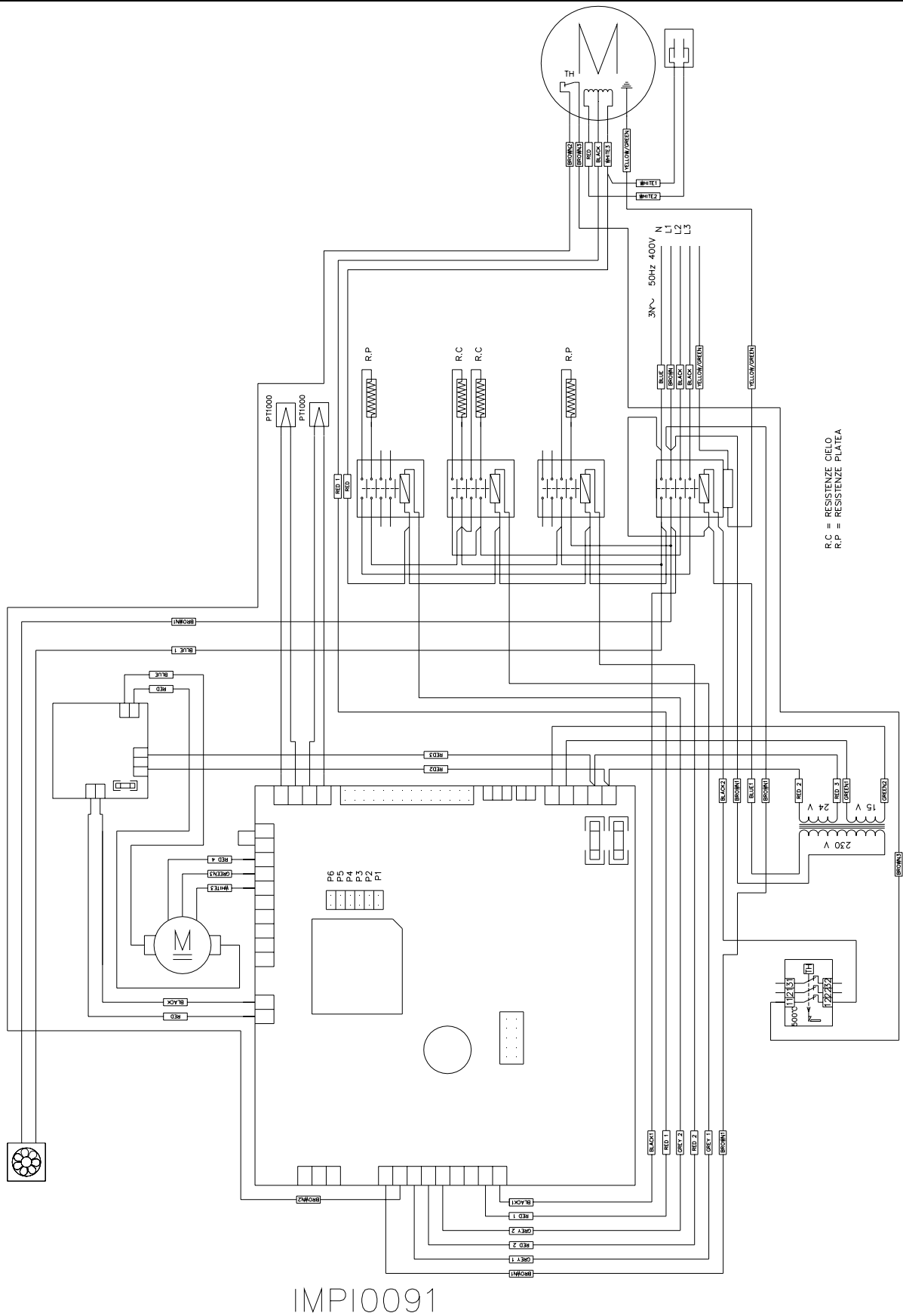

Fig. 10-4 Wiring diagram DPZ6030E - 400 Vac. ~ 3+N 50-60Hz

10.4 EXPLODED VIEWS AND LIST OF SPARE PARTS

For more complicated work and where there are breakages we ask you to please contact us. To simplify the breakdown search and any necessary replacements of damaged parts we give a list, here below of spare parts and exploded diagrams showing each of the listed parts.

The exploded diagrams are of the GGM cooking module but they are also applicable to the DPZ6030E module. The reference figure are Fig. 10-5, Fig. 10-6, Fig. 10-7, Fig. 10-8 end Fig. 10-9.

TABLES OF REFERENCE CODES

POS	DESCRIPTION	CODE
1	Door for DPZ6030E	PORT0132
2	Entry panel	FIAN0139
3a	Upper right diffuser	CARP0252
3b	Lower left diffuser	CARP0318
4	Chamber body	CAME0042
5b	Top Heating element	RESI0081
	Bottom heating element	RESI0082
6	Motor support panel	FIAN0144
7	Fan	VENT0018
8a	Motor fan 50Hz	MOTO0030
8b	Motor fan 60Hz	MOTO0041
9	Motor guard	CART0016
10	Rear panel	FIAN0127
11	Conveyor belt joint guard	CARP0340
12	Upper guard	-
13	Gear reducer	MOTO0052
14	Rear guard	CART0048
15	Door	PORT0104
16	Glass	CRIS0034
17	Glass holding frame	CARP0251
18	Door frame	PORT0102
19a	Lower right diffuser	CARP0253
19b	Lower left diffuser	CARP0317
20a	Base, high	-
20b	Base, low	0SV2A00
21	Panel	FIAN0142
22	Base	ZOCC0037
23	Exit panel	FIAN0125
24	Slide gate	CARP0346
25	Entry drawer	CARP0255
26	Exit drawer	CARP0256
27	Control guard	CART0015
28	Gear reducer support	SUPP0068
29a	Control panel – electromech. version	PANN0120
29b	Control panel - electronic version	PANN0090
30	Fan	VENT0012
31	Filter	FLTR0003

MAINTENANCE

32	Enclosure	VENT0013
33	Bush	BOCC0013
34	Idle shaft	MECC0467
35	Pipe for idle shaft	MECC0472
36	Feed wheel	MECC0035
37	Feed spacer	MECC0036
38	Conveyor belt	RETE0013
39	Pass support	CUSC0022
40	Feed shaft	MECC0125
41	Conveyor Joint hub	MECC0114

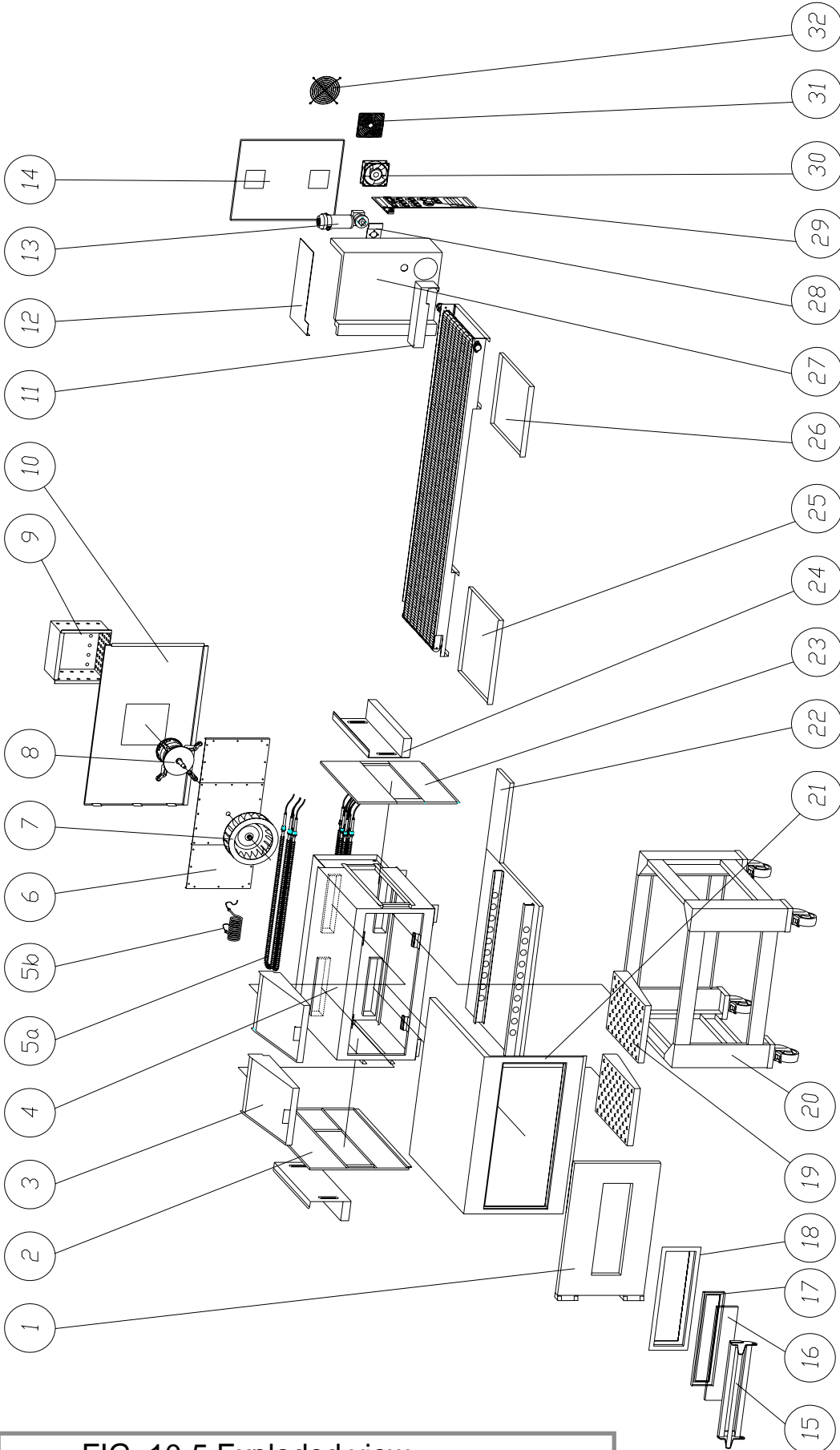

FIG. 10-5 Exploded view

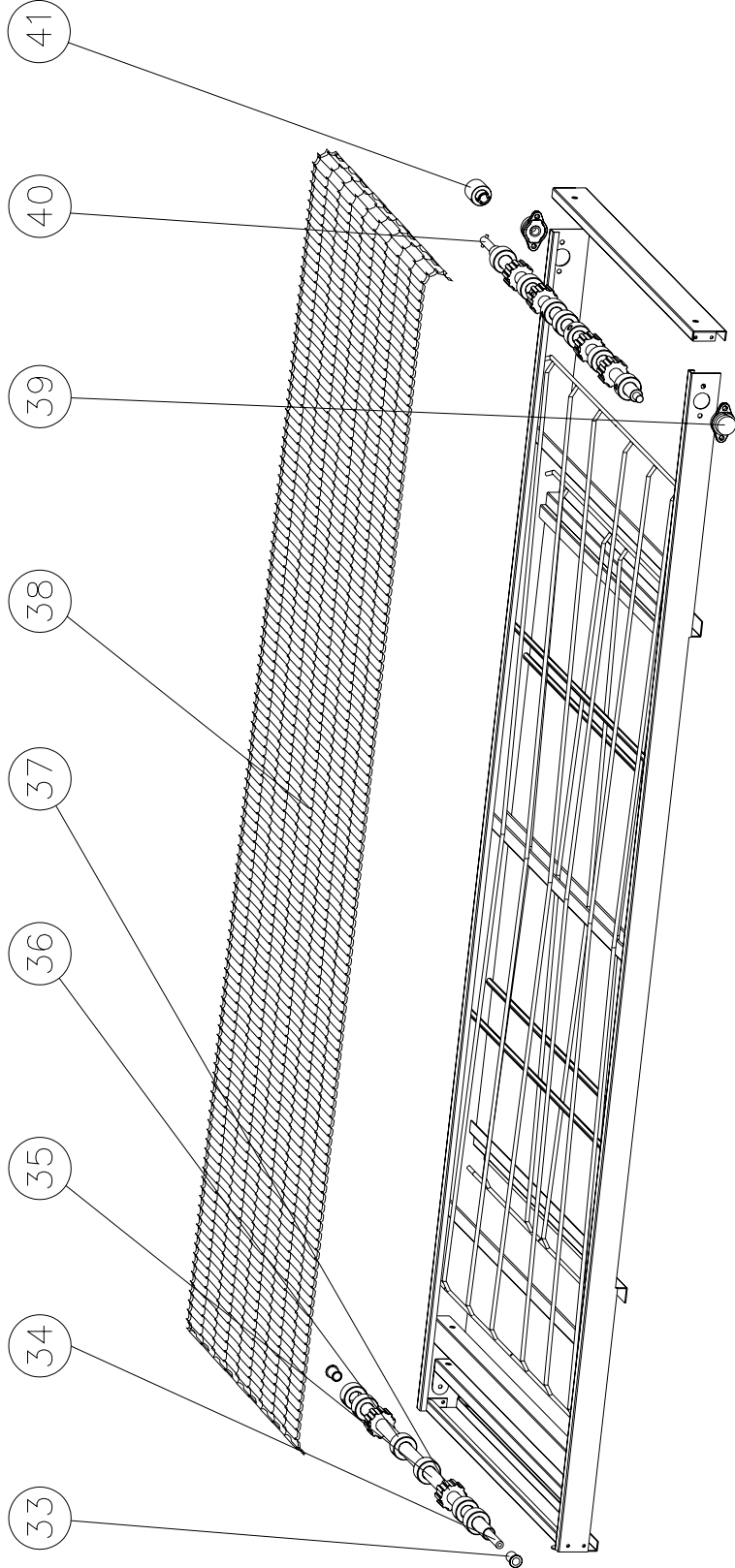

FIG. 10-6 Exploded view of conveyor belt

**SPARE PARTS LIST FOR ELECTRIC COMPONENTS
ELECTROMECHANICAL VERSION**

POS	DESCRIPTION	CODE DPZ6030E
1	Red switch	INTE0004
2	Thermo regulator	TERM0012
		TERM0060
3	Energy regulator	TERM0014
		TERM0050
4	Transformer	ELET0094
5	4-poles relay switch	ELET0002
		ELET0160
		ELET0432
6	Terminal fuse	ELET0058
7	Earth terminal 10sqmm	ELET0053
8	Terminal 10sqmm	ELET0046
9	500°C Safety Thermostat	TERM0005
10	Green light	LAMP0006
11	Condensator	ELET0034
12	Yellow light	LAMP0002
13	J Thermocouple 6x200	TERM0020
14	Handle	MANI0021
15	Graduated Handle	MANI0022
16	Green switch	INTE0010
17	Yellow switch	INTE0009
18	Potentiometer	ELET0200
19	Motor feed card (electromechanical version)	ELET0203
20	J Thermocouple	TERM0020

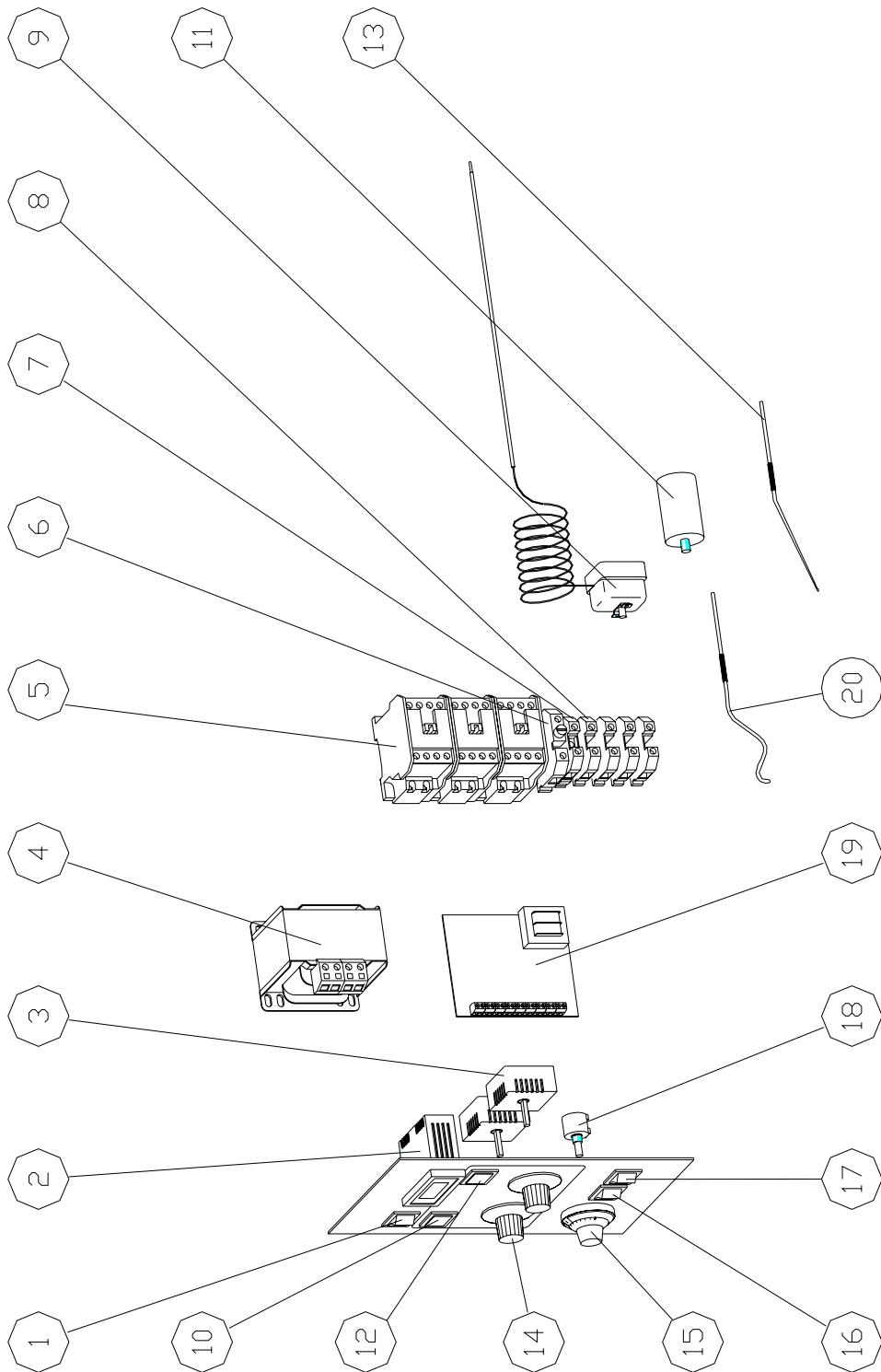

FIG. 10-7 Exploded view of electrical parts;
electromechanical version DPZ6030E

**SPARE PARTS LIST FOR ELECTRIC COMPONENTS
ELECTRONIC VERSION**

POS	DESCRIPTION	CODE DPZ6030E
1	Keyboard	ELET0165
2	Display card	ELET0155
3	PT1000 Thermocouple	TERM0019
4	Earth terminal 10sqmm	ELET0053
5	4-poles relay switch	ELET0002
		ELET0160
		ELET0432
6	Condensator	ELET0034
7	500°C Safety Thermostat	TERM0005
8	Base board	ELET0212
9	Transformer	ELET0156
10	Motor feed card (electronic version)	ELET0213
11	PT1000 Thermocouple	TERM0019

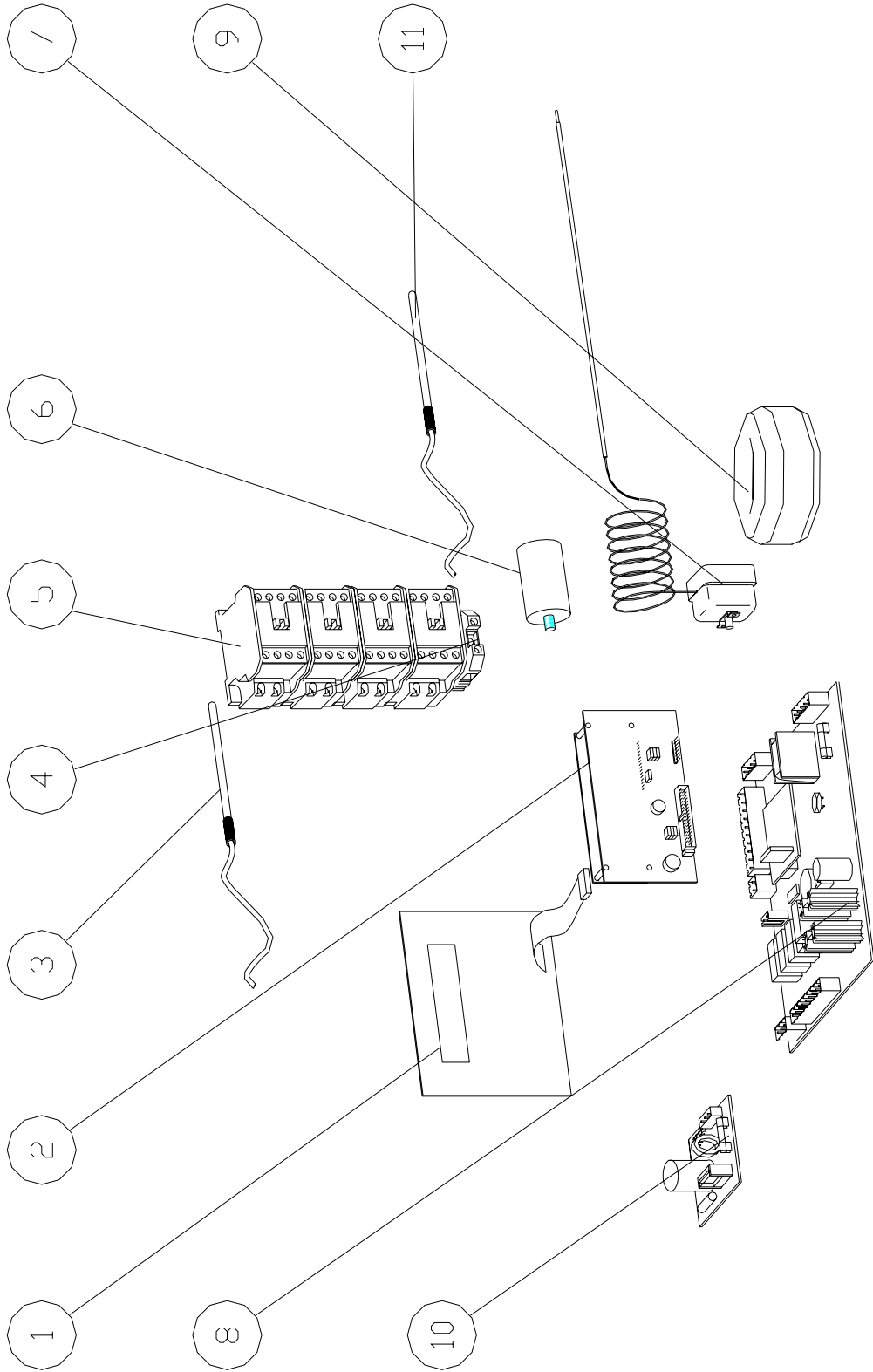
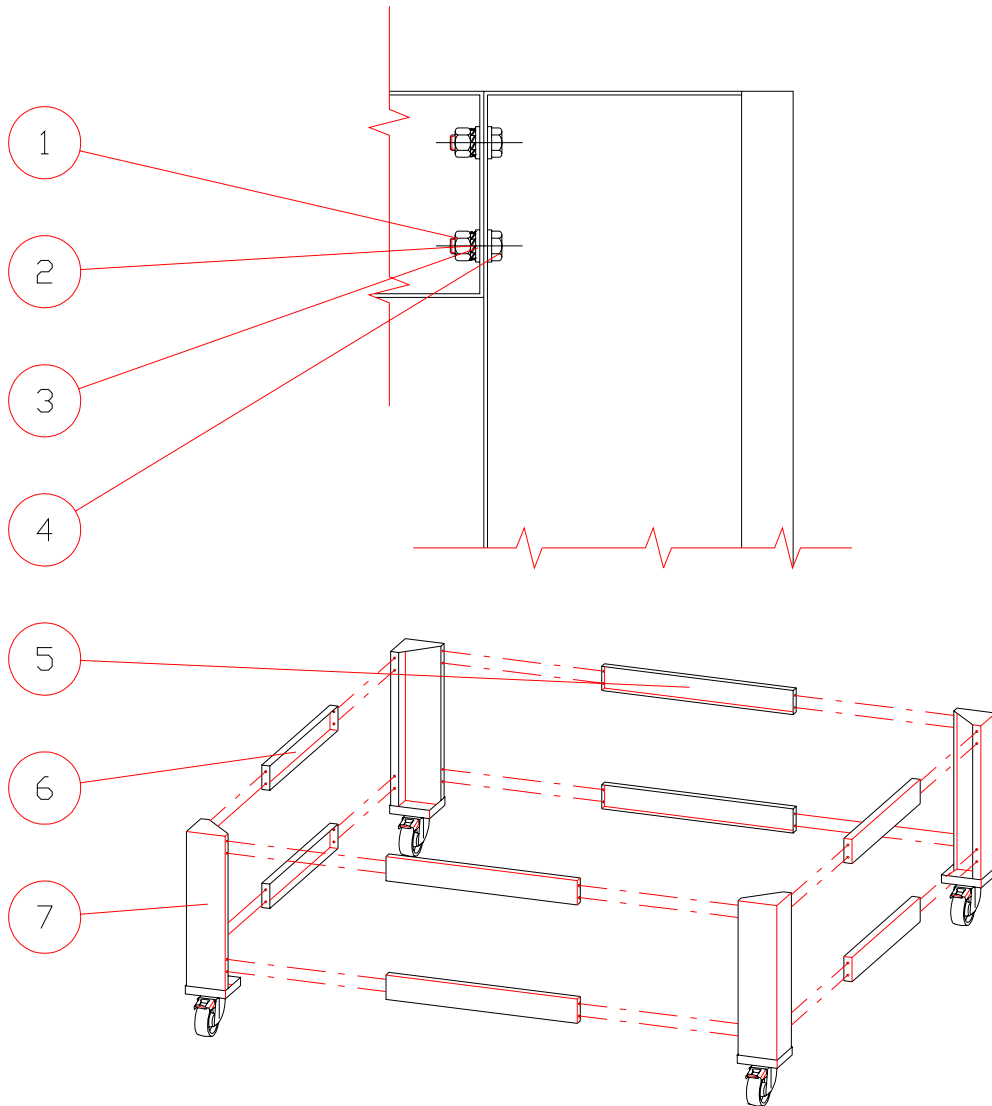

FIG. 10-8 Exploded view of electrical parts; electronic version DPZ6030E

FIG.10-9. - Base assembly diagram



ITEM	DESCRIPTION	CODE	Q.TY
1	NUT M6 8G	DIN 6915	32
2	TOOTHED WASHER Ø 6,4	DIN 6798	32
3	WASHER Ø 6,4		64
4	SCREW TE M6x18 8,8	DIN 933	32
5	CROSSPIECE		4
6	CROSSPIECE		4
7	UPRIGHT		4

11.DECOMISSIONING AND DEMOLITION

Before proceeding with the decommissioning disconnect the electrical supplies to the equipment and any other connections there may be and then move the modules using suitable means such as: forklift trucks, hoists, and so on.

The ovens are made up of the following materials: stainless steel, coated steel, glass, ceramic material, rock wool and electrical parts.

For the purposes of demolition therefore the materials have to be separated in observance with the norms in force in the place where the machine is being dismantled.

In any case do not dispose of into the environment.

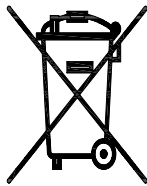

Separate collection. This product must not be disposed of with normal household waste. Local regulations may provide for separate collection of this kind of product.