

INSTALLATION AND USER MANUAL



UNDER COUNTER DISH WASHING MACHINES

→ INSTALLATION

→ USER MANUAL

→ MAINTENANCE
INSTRUCTIONS



UNDER COUNTER DISH WASHING MACHINES

INSTALLATION AND USER MANUAL

1. INSTRUCTION MANUAL

1.1 AIMS AND SCOPE





Descriptions for safe use and maintenance of the product

1.2 RESPONSIBILITIES

Responsibilities of Product's Owner: The product's owner is responsible for applying of safety rules stated in this Instruction Manual or getting them applied by delegating his authorities and risks, which may arise due to not applying. The product's owner is also responsible for the periodical maintenance of the machine.

Responsibilities of the Manufacturers: The manufacturer is responsible for the risks due to manufacturing and assembling faults, even though all requirements stated in this manual

1.3 SIGNS

| | |
|---|--|
|  | WARNING: This sign indicates that it must be complied with the instructions related to the subject; otherwise, the risky conditions, in which there can occur some damages and dangers |
|  | CAUTION: This sign indicates any risky conditions, which can cause damages in material and injuring of people, provided that one does not pay attention and states that one must be careful. |
|  | DANGER: This sign indicates high risky conditions in which people can be injured, provided that one does not pay attention and the rules always to be complied with. |
|  | DANGER: This sign indicates high risky conditions in which the people can be injured or can die due to electrical shock. |
|  | Equipotential connection terminal (If necessary, it must be connected to other equipment to make equal the potential) |





INSTALLATION AND USER MANUAL

TECHNICAL DATA

| | | | |
|--|-------|-----------------|---------------------------|
| CAPACITY | | | |
| PLATES | | 60' | 540 |
| BASKET | | | |
| BASKET FOR 16 PLATES | 50X50 | n | 1 |
| GLASS-CUP BASKET | 50X50 | n | 1 |
| ELECTRIC | | | |
| VOLTAGE | | V | 220-230 AC V, 3~ N , 50Hz |
| WASHING TANK HEATER | | W | 2500 |
| RINSING WATER HEATER | | W | 4500 |
| MAXIMUM POWER | | W | 5000 |
| MAIN SUPPLY CABLE | | mm ² | 3X2.5 RNF TYPE |
| FEED WATER | | | |
| WATER INLET PRESSURE | | bar | 02.Nis |
| WATER HARDNESS | | °Fr | 15 |
| WATER INLET TEMPARATURE | | °C | 45-50 |
| WATER INLET CONNECTOR DIAMETER | | ∅ | ¾" |
| WATER INLET CONNECTOR DIAMETER DRAINAGE HEIGHT | | ∅mm | 32 |
| DRAINAGE HEIGHT | | cm | 35 |
| WASHING | | | |
| TEMPARATURE | | °C | 50-55 |
| WASHING TANK CAPACITY | | lt | 29 |
| WASHING PUMP | | HP | 0,75 |
| WASHING DURATION | | | 2 Min |
| RINSING | | | |
| TEMPARATURE | | °C | 80-85 |
| RINSING WATER CONSUMPTION | | lt/basket | 2,5 |
| DIMENSION | | cm | 67x60x59 |
| GROSS WEIGHT | | kg | 60 |

INSTALLATION AND USER MANUAL

1.4 TRANSPORTATION AND INSTALLATION

| | |
|---|---|
|  | During transportation, take necessary precautions against the risk of falling down and being turned upside down for the product. |
|  | Place the product onto a flat and solid ground. |
|  | Do not install the product near the flammable and explosive materials and do not keep any flammable and explosive material near the furnace, while it is working. |
|  | Keep surely a fire extinguisher near the furnace and check whether the periodical checking of the fire extinguisher has been implemented or not. |

1.5 GENERAL PRINCIPLES

- The users agree and accept to be in conformity with all requirements included in using manual, otherwise the machine shall be deemed OUT OF GUARANTEE COVERAGE.
- The user also accepts that he/she was fully informed about the limited guarantee liability.
- Any living body or any object should not be placed on machines. In addition, any living body should not be put inside the machines.
- It should not be allowed the children or any other unauthorized persons to operate the machines.
- Any electrical operating machines should be cleaned after the required electrical connections switched off.
- The electrical products should never be operated if any sufficient grounding installation had not been practiced in addition; the LEAK CURRENT RELAY and fuse groups had not been installed in control box supplying the electrical energy to the machine.
- The cover of any machine should not be opened during the period of working.
- Use , foam free and foam controlled liquid detergent and polisher in your machine. While the device is working , do not open in any way the cover of the device with cover.
- Be careful not to squeeze your hands while closing the covers.
- The machines and covers should not be treated as step or ladder in any case.
- The electrical devices should never be washed in the manner of spraying water. They should be cleaned by means of rubbing after switching the power off the power had been switched off.

INSTALLATION AND USER MANUAL

- Any scratchier or stripper tools should not be used during the cleaning.
- This manual verifies all machines were tested and the required security controls were done in due diligence so delivered under operating conditions.
- Do not connect the devices, which are in connection with hose, to the waterlines in the temperatures below 5°C and above 50°C.
- Use rubber gloves during the cleaning and maintenance practices procedures
- Do not remove the labels and panels of the devices.
- Do not spray machine with water.
- In order to use efficiently and to decrease minimum the energy expenses, supply water in 50°C to your devices with electrical heating system. Additionally, in order to elongate the life of your device, use surely soft water in 15 °F. If you do not have the water in this softness, use a water softening device.
- Check the inlet pressure 200-400 kPa.
- Take care not to trap your hand when closing the door.
- Manufacturer firm is not responsible for the printing errors, which take place in the instruction manual and device description catalogue, coming together with the device.
- Manufacturer has the right to make all changes, which he/she deems to be useful for user or him/her. However, he/she guarantees that the features related to primary functionality and safety of the device will be maintained.
- In case of any failure, cut the electrical and water connection of the device off and apply to the authorized services.
- In your device, do not wash the things such as pots and pans, saucepans in different and big sizes, which do not fit to use purpose.
- While the water in the boiler of your device is hot, do not insert your hand into the boiler. Water that is hot and contains detergent can be harmful for your skin. In such a condition, rinse your hand with warm water.
- Power cord must be min. H05RN-F type.
- Cable diameter must be min 3x2.5 mm²
- Grounding line must be continuously checked.

1.6 COMING THINGS TOGETHER WITH THE PRODUCT

- A. Description Catalogue
- B. User/Maintenance/Assembling Manual
- C. Guarantee Document
- D. Water supplying hose

INSTALLATION AND USER MANUAL

E. Drainage hose to sewer system

F. Basket

- Dear Customers, please check the above written auxiliary equipment to be given with the machine on delivery. If you notice any damage or loss occurred during the transportation then you should request the transporter to issue any written report including the relevant damage or loss.

1.7 DESCRIPTION OF DEVICE WITH EXPLANATIONS

- Washing machine has been manufactured regarding the hygienic standards.
- The frame (inside/outside), including chassis, panel and boiler, has been wholly manufactured from stainless steel material.
- The legs are in adjustable feature and manufactured from stainless steel material.
- Washing tank is automatically filled and continuous level controlled.
- Washing and rinsing water temperatures are automatically controlled via two thermostats working independently.
- Its performance and efficiency are higher than those of its competitors.
- Program duration is 2 min.
- Pumps have been manufactured as detergent and hot water resistant.
- Motors have a heat resistant feature and are protected by cooling of fan against higher temperatures.
- The insulation of boiler has been provided by glass wool that is a special insulation material. Thus, heat losses can be reduced to minimum level and prevented the wasting of energy as well. System has been fully secured by means of thermal and electrical protectors. Access to electrical panel, executing of maintenance works and inspections have been quite facilitated. Full automatically washing has been performed at 55 °C. Rinsing is performed at 80 to 85 °C by hot and fresh water. Electrical equipment and cables comply with European Standards and safety regulations.

1.8 REPLACING THE DEVICE AND PREPARING FOR START UP

1.8.1 INSTALLATION BEFORE ASSEMBLING

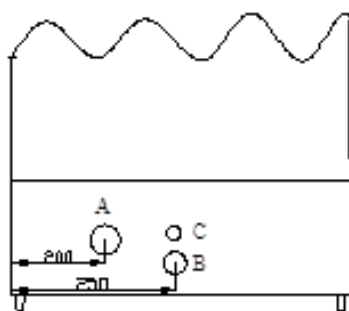

A-WATER INLET
B-WATER OUTLET
C-POWER CABLE

INSTALLATION AND USER MANUAL

1.8.2 PREPARATION FOR START UP

- Open the packing of the device and remove all protective tapes.
- Opening the cover of the device, take out the instruction manual and guarantee document.
- Place the devices with adjustable legs by adjusting their legs and the device with fixed legs by aligning the ground.
- Connect the elbowed part of the supply hose the solenoid valve of the device, the other end, to the tap.
- Clamp one end of drainage hose to the drainage outlet of the machine. Connect the other end of it to sewer system coming from the ground.
- Drainage hose must not be twisted, folded, and bent more than 90°
- Supply water must be at 50°C in temperature and 202 to 404 kpa in pressure
- If the connection to sewer system on the ground is above the drainage outlet of the machine, a drainage pump must be used.
- If water pressure is higher than 404 kpa, a pressure reducer valve must be used.
- If the water pressure is lower than 202 kpa, a water pressurizing pump must be used.
- Supply water of the machine must be a 10 to 15 ° Fr.
- If it is not so, a water softening device must be used.
- Drainage line to sewer system on the ground, which drainage pipe was connected to, must have a siphon, in order to prevent bad smells.
- Required voltage a washing machine is 380-400 AC V / 50 Hz.
- Make a grounding connection and be sure that this connection has been made correctly.
- Be sure that there is energy supply in the system.
- On the condition that you have fulfilled all requirement for operating the device, your device is ready for working.

1.8.3 FINAL CHECK BEFORE START UP

- The users should fulfill the following last-controls by accepting the required couplings of fresh water, electric, wastewater, installations to be carried out by the authorized technicians;
- You must be sure that the power supply and grounding installation are ensured as required in leaflets of electrical equipment.
- You must be sure that the feeding water has been installed and the water vane is turned on.

INSTALLATION AND USER MANUAL

- You must be sure that the wastewater installation was done properly and discharging hose was coupled with discharging pipe tightly.

2. USER MANUAL

START UP

- Have a specialist electrician your device working 220-230 V connect to the K-automat fuses group.
- Device must not be operated without being made adequate grounding and from the electricity source, which do not have leak current relay.
- Water supply connection must be made and its valve must be open
- Water drainage connection must be made.
- Before placing things into the baskets, solid wastes must be cleaned and subjected to pre-washing by washing buttery with sprayer.
- Do not place more dirty dishes than stated in the Table into baskets.
- Do not use any detergent for pre-washing.
- Keep the very dirty dishes (waiting ones more than 2-3 hour) under water until complete dissolving
- Do not wash materials made of plastic.
- Use foam controlled liquid detergent in your machine.
- Have the detergent firm dosing apparatus to supply detergent into your machine connect.
- Have the detergent firm dosing apparatus to supply polisher into your machine connect.
- Check the water supply hose and water drainage connection.
- Fix overflow pipe into its place.
- Open the valve of pressured hot water supply.
- Place the basket, in which you place the things to be washed, in machine.
- Close the cover of the device.

CONTROL PANEL

- Full automatic washing cycle at 55 C with a choice of three different programs from 1 to 2 minutes.

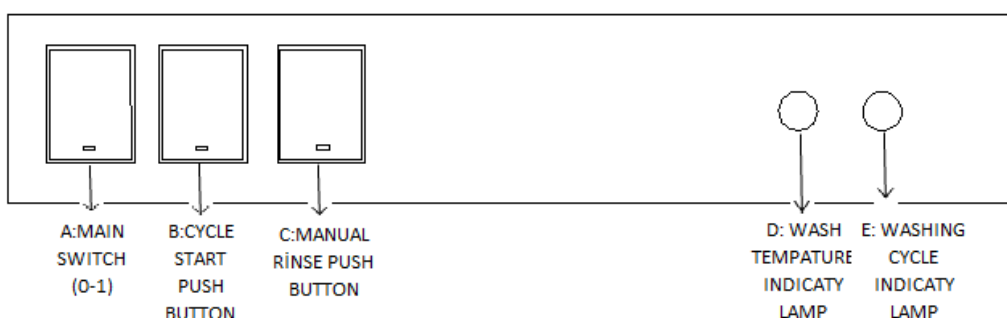

INSTALLATION AND USER MANUAL

- Switch on “stand by” switch. Observe that energy lamp lights on.
- Machine takes the water into the tank and heats it up. When the water is ready, the lamp “Water is ready” lights on.
- As long as the lamps are lighting on, washing continues. When they light off, the program will be finished.
- For the next washing periods, in each period, it is pressed on white/red washing button in the middle of selection switch.
- Washing time
- Programme : 120 sec.
- Press F button for starting the program.
- During washing and rinsing, the button “It is washing” lights on. After 4 seconds from finishing of rinsing, this lamp lights off.
- When this lamp lights off, the operation programmed is completed.
- Open the cover and take out the pots. You can load in the machine the other thing to be washed.
- When the cover is opened, machine stops.
- If the cover is opened or closed after the program starts, program continues to run from the previous point it stops.

2.1 ELECTRIC DIAGRAM

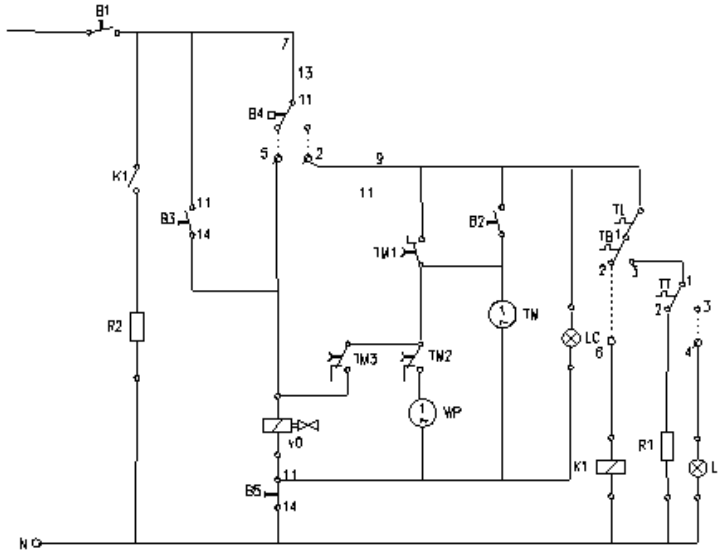

- B1- ON-OFF SWITCH/ACMA KAPAMA ANAHTARI
 B2-PUSH BUTTON CYCLE / START ANAHTARI
 B3-MANUAL RINSE / MANUEL DURULAMA ANAHTARI
 B4-PRESSURE SWITCH /SU SEVIYE SIMCI
 B5-DOOR SWITCH / KAPAK SIMCI
 TL-SAFETY TERMOSTAT BOILER/ BOYLER EMNİYET TERMOSTATI
 TB- TERMOSTAT BOILER/ BOYLER TERMOSTATI
 TK- TERMOSTAT TANK/ KAZAN TERMOSTATI
 R1- TANK HEATER 2.5 kW / KAZAN ISITICISI 2.5 kW
 R2- BOILERHEATER 2.5 kW / BOYLER ISITICISI 2.5 kW
 TM- TIMER MOTOR / TIMER MOTORU
 WP- WASH PUMP / YIKAMA POMPASI
 TM1- SELF HOLDING/ KIL?TLEME KONTAGI
 TM2- WASH / YIKAMA
 TM3- RINSE/ DURULAMA
 LK-WATER HEAT/SU HAZIR
 LC- CYCLE/ YIKAMA YAPIYOR

3. MAINTANCE AND CLEANING

Implement the following periodical maintenance so that the product should work in safe and long life

3.1 DAILY MAINTANCE

- When the water in washing tank gets dirty, it must be replaced by fresh water. For this purpose, bring the "0-1" switch of the machine into "0" position and close the device.
- Switch off the electricity, switching off the switch.
- Opening the cover of the device, sponge the solid wastes in the device

3.2 CLEANING THE DEVICE

- When the water in washing tank gets dirty, it must be replaced by fresh water.
- For this propose, bring the STAND BY and START swatches of the machine into “stop” and close the device.
- Closing the switch, switch the electricity off.
- After opening the cover, be careful of not impacting the cover holder.
- Take out the overflow pipe.
- Remove the washing and rinsing butterfly nozzles and clean them. Wash the rinsing nozzles and rinse them.
- Taking out the surface filters and pump suction filters, clean them by brush under the flowing water.
- Fix all parts in their place in such a way conforming to their original conditions.
- Close the cover of the device.
- Open the relevant switch on the control panel supplying electric to the device. Bring the “STAND BY and “START” swatches into starting position.
- For complete cleaning of the device, run the device for 5 minutes
- Bring the “START” switch into “pause” position.
- Open the cover.

3.3 WEEKLY MAINTANCE

- When the water in washing tank gets dirty, it must be replaced by fresh water.
- For this propose, bring the STAND BY and START swatches of the machine into “stop” and close the device.
- Closing the switch, switch the electricity off.
- After opening the cover, be careful of not impacting the cover holder.
- Take out the overflow pipe.
- Remove the washing and rinsing butterfly nozzles and clean them. Wash the rinsing nozzles and rinse them.
- Taking out the surface filters and pump suction filters, clean them by brush under the flowing water.
- Fix all parts in their place in such a way conforming to their original conditions.
- Close the cover of the device.
- Open the relevant switch on the control panel supplying electric to the device. Bring the “STAND BY and “START” swatches into starting position.

- For complete cleaning of the device, run the device for 5 minutes
- Bring the “START” switch into “ pause” position.
- Open the cover.

3.4 SAFE LIFE

The safe life of the product is 5 years.

3.5 INTERVENTION AFTER FAILURE

3.5.1 FAILURES / CAUSES

a. Device is not working:

- Check whether there is electric supply to the device.
- Be sure that there is electric supply to the stand by and start switches
- Be sure that electric supply to level switch and solenoid valve.

b. There is no being filled:

- Check the level switch.
- Check whether there are any contaminants in the tube in washing tank
- Be sure that there is adequate level of water in washing tank.
- Check the solenoid valve opens and closes. Open and close the switch. If it does not work, change by new ones.

c. Washing tank is not being filled or there is no rinsing:

- Be sure that the tap supplying water is open
- Check whether drainage pipe is fixed in its place or not.
- Be sure that stand by and start switches are open.
- Be sure that main fuse supplying the machine is in active.
- Check the fuse of machine.
- Be sure that there is no plugging in butterfly nozzles due to contaminants.
- Be sure that sufficient amount of air in air housing
- Take out the overflow pipe and empty the tank completely.
- If this is not a solution for the problem, change the level switch.
- Opening and closing the stand by switch, check the solenoid valve. If it does not work, change it by new one.

d. Washing tank is slowly being filled.

- Be sure that the tap supplying water is open.
- Check the water pressure, if it is lower than 202 kpa, use the pressurizing pump.
- Remove the water supplying hose. Take apart the filter of solenoid valve and clean it
- Be sure that rinsing nozzles are not plugged
- Be sure that overflow pipe completely sits in its housing. If there is pressure reducing valve, take it out.

e. Machine is not heating washing and rinsing water :

- After checking that overflow pipe is connected to its place, be filled the washing tank.
- Check whether or not the thermostat of rinsing water boiler is set to 80 °C, and the thermostat of washing water, to 50°C
- Check the cables and their connections.

f. Washing tank is not being emptied:

- Washing tank can not be emptied due to solid wastes. Inspect the water drainage hose from overflow pipe to siphon on the ground. Be sure that it is clean.

g. Machine is not efficiently working:

- Be sure that pump suction filter is clean
- Be sure that the nozzles of washing butterfly are clean
- Be sure that adequate amount of detergent is delivered to the machine.
- Selected washing program is very short due to the fact that the pots are dirty
- Select the longer program and run again the machine.
- Check whether water temperature in washing tank is correct or not.

h. There is no drying: (Models with drying system)

- Be sure that the amount of polisher injected to the machine is correct
- Check the thermostat of rinsing water is set to 80 °C.

i. Condensation in the glasses.

- Do not store the glasses on a flat surface.
- The amount of dosed polisher is not correct.
- The amount of dosed polisher is not correct.

j. Striped glasses:

- Use only foamless detergent.
- There is excess amount of foam in washing tank:

INSTALLATION AND USER MANUAL

- Water temperature in washing tank must not be lower than 50°C.
- Check the detergent and polisher dosing apparatus. There can be excessive dosing
- Be sure that machine was not cleaned by foamed detergent. Empty the tank and boiler.
- If foamed detergent was used, empty the tank and be filled it by fresh water. Continue to make this operation until the foam disappear.

k. There is stain on the glass :

- Decrease the amount of dosed polisher. Acceptable dosage is 0,1 cc / liter water.

l. The arms of washing butterfly are not correctly rotating.

- Remove the washing arm and clean it.
- Be sure that water pressure is more than 202 kpa, If the pressure is lower, mount a pressurizing pump.



GGM Gastro International GmbH
Weinerpark 16
D-48607 Ochtrup

www.ggmgastro.com info@ggmgastro.com
+49 2553 7220 0